

UNCLASSIFIED

AD. 131 477

DEFENSE DOCUMENTATION CENTER

FOR

SCIENTIFIC AND TECHNICAL INFORMATION

CAMERON STATION ALEXANDRIA, VIRGINIA



UNCLASSIFIED

NOTICE: When government or other drawings, specifications or other data are used for any purpose other than in connection with a definitely related government procurement operation, the U. S. Government thereby incurs no responsibility, nor any obligation whatsoever; and the fact that the Government may have formulated, furnished, or in any way supplied the said drawings, specifications, or other data is not to be regarded by implication or otherwise as in any manner licensing the holder or any other person or corporation, or conveying any rights or permission to manufacture, use or sell any patented invention that may in any way be related thereto.

131477

ARDC-TR-58-54  
ASTIA DOCUMENT No. AD 131 477

10

# PROCEEDINGS OF THE SECOND TRI-SERVICE CONFERENCE ON BIOLOGICAL EFFECTS OF MICROWAVE ENERGY

8, 9, 10 JULY 1958

~~FILE COPY~~  
~~Subject to~~  
~~ARDC-TR-58-54~~  
~~ARRINGTON HALL STATION~~  
~~ARRINGTON 12, VIRGINIA~~  
~~ASTIA~~

Compiled and Edited by  
EVAN G. PATTISHALL  
FRANK W. BANGHART  
*Project Directors*  
University of Virginia

SPONSORED BY  
ROME AIR DEVELOPMENT CENTER  
AIR RESEARCH AND DEVELOPMENT COMMAND, HDQS.

CONTRACT AF 18(600)-1792  
DIVISION OF EDUCATIONAL RESEARCH  
UNIVERSITY OF VIRGINIA  
CHARLOTTESVILLE, VIRGINIA  
September 1958

ASTIA  
ARLINGTON HALL STATION  
ARLINGTON 12, VIRGINIA  
ASTIA: TISS

FILE COPY

ASTIA  
JIPDR

**Best  
Available  
Copy**



ARDC-TR-58-54  
ASTIA Document No. AD 131 477

PROCEEDINGS OF THE SECOND TRI-SERVICE CONFERENCE  
ON BIOLOGICAL EFFECTS OF MICROWAVE ENERGY  
8, 9, 10 July 1958

George M. Knauf, Colonel, USAF (MC), Chairman

Compiled and Edited by  
Evan G. Pattishall  
Frank W. Banghart  
Project Directors  
University of Virginia

Sponsored by  
Rome Air Development Center  
Air Research and Development Command, Hdqs.

Contract AF 18(600)-1792  
Division of Educational Research  
University of Virginia  
Charlottesville, Virginia

September 1958

## PREFACE

For several years, research on the biological effects of microwave energy was relegated the role of a "stepchild" among other research problems competing for support. The bio-effects effort was shifted among various branches and locations within the Armed Services, until less than two years ago when the Air Force was given the tri-service coordinating responsibility in this area. As a means of fulfilling this responsibility, the Rome Air Development Center and the Air Research and Development Command Headquarters held a tri-service conference on 15-16 July 1957 to bring together key researchers in the bio-effects area so that each department within the Armed Services could discuss on-going and needed research.

Within the last year, the research effort matured so rapidly that it was thought desirable to hold a second tri-service conference on the biological effects of microwave energy so that military, university, and industrial researchers could keep informed on the activities and accomplishments to date. The conference was held 8, 9, 10 July 1958 under the able chairmanship of George M. Krauf, Colonel, USAF(MC), at Rome Air Development Center, Griffiss Air Force Base, Rome, New York. It was especially fitting that Dr. Krauf should organize and sponsor such a conference, because of the outstanding competence and leadership he has demonstrated in this area.

The following papers represent the contributions of many leaders in the fields of biology, physics, medicine, engineering,

and psychology. Every attempt has been made to present the papers for the reader as they were presented at the conference. In some cases additional information has been incorporated into the presentations. It is hoped that no injustices to content or persons have resulted from the task of editing the manuscripts and transcriptions.

Special thanks are expressed to Colonel Knauf, Mr. Brownstein, and the staff of RADC for their hospitality and skillful handling of the arrangements for the conference. The editors also wish to express thanks to Miss Mary Ann MacDougall at the University of Virginia for her able administrative assistance in preparing these proceedings for publication.

It is hoped that the following presentations will be useful in summarizing the present knowledge on the biological effects of microwave energy and that it may be of value as source material for future researchers.

Evan G. Patt'shall  
Frank W. Banghart  
Charlottesville, Virginia  
September, 1958

## TABLE OF CONTENTS

	<u>Page</u>
WELCOME	1
. . Donald P. Graul, Brig Gen, USAF	
OUTLINE AND PURPOSE OF MEETING	3
. . George M. Knauf, Colonel, USAF (MC)	
PHYSICAL CHARACTERISTICS OF MICROWAVES AS RELATED TO BIOLOGICAL EFFECTS	9
. . Dr. Joseph H. Vogelmann	
DISCUSSION OF LONG-RANGE DEVELOPMENT PLANS IN THE AIR FORCE	19
. . Harry Davis	
MOLECULAR RESPONSE CHARACTERISTICS TO ULTRA- HIGH FREQUENCY FIELDS	33
. . Dr. Herman P. Schwan	
NEW CONCEPTS IN PERSONNEL PROTECTION	49
. . George M. Knauf, Colonel, USAF (MC)	
THE PATHOLOGY OF HYPERPYREXIA	54
. . Dr. Frank Hartman	
RADIO FREQUENCY HAZARDS ABOARD NAVAL SHIPS	70
. . John Roman	
MICROWAVE RADIATION HAZARDS PROBLEMS IN THE U. S. ARMY	79
. . Lloyd C. MacMurray, Lt Col, USA (MSC)	

	<u>Page</u>
PEARL CHAIN FORMATION	88
. . Dr. Julia Herrick	
FIELD TRIAL OF RICHARDSON MICROWAVE DOSIMETER	97
. . Dr. Thomas Ely	
HUMAN ENGINEERING APPLICATIONS AS RELATED TO PERSONNEL PROTECTION	105
. . Anthony Debons, Lt Col, USAF	
MEDICAL CONSIDERATIONS OF EXPOSURE TO MICROWAVES (RADAR)	112
. . Dr. Charles I. Barron	
RECOMMENDED TOLERANCE LEVELS OF M-W ENERGY CURRENT VIEWS OF THE GENERAL ELECTRIC COMPANY'S HEALTH AND HYGIENE SERVICE	118
. . Dr. B. L. Vosburgh	
REVIEW OF THE BIOLOGICAL EFFECTS PROGRAM	124
. . George M. Knauf, Colonel, USAF (MC)	
SURVEY OF MICROWAVE ABSORPTION CHARACTERISTICS OF BODY TISSUES	126
. . Dr. Herman P. Schwan	
REVIEW OF THE WORK CONDUCTED AT TUFTS UNIVERSITY (USAF Sponsored)	146
. . Dr. Russel L. Carpenter	
REVIEW OF THE WORK CONDUCTED AT UNIVERSITY OF ST. LOUIS (USN Sponsored)	169
. . Dr. Alfred W. Richardson	

	<u>Page</u>
REVIEW OF THE WORK CONDUCTED AT UNIVERSITY OF ROCHESTER (USAF Sponsored)	175
. . Dr. S. Michaelson Dr. Joe W. Howland Dr. R. Dundero	
REVIEW OF THE WORK CONDUCTED AT UNIVERSITY OF BUFFALO (USAF Sponsored)	189
. . Dr. Herry Fischer Dr. Clinton Osborn <u>et al</u>	
REVIEW OF THE WORK CONDUCTED AT TULANE UNIVERSITY (USN Sponsored)	202
. . Rene Baus <u>et al</u>	
REVIEW OF THE WORK CONDUCTED AT UNIVERSITY OF MIAMI (USAF Sponsored)	215
. . Dr. Moreno Keplinger	
REVIEW OF THE WORK CONDUCTED AT UNIVERSITY OF CALIFORNIA (USAF Sponsored)	234
. . Dr. Baruch S. Jacobson Dr. Charles Susskind	
REVIEW OF THE WORK CONDUCTED AT STATE UNIVERSITY OF IOWA (USAF Sponsored)	242
. . Dr. Charles J. Imig Dr. Gordon W. Searle	
REVIEW OF THE WORK CONDUCTED AT SOUTHWEST RESEARCH INSTITUTE (USAF Sponsored)	254
. . W. L. Rollwitz	

## WELCOME

by

Brig. Gen. Donald P. Graul, USAF  
Commander, Rome Air Development Center

### COLONEL KNAUF:

It is a pleasure this morning to introduce my boss to you.

You know we all have a tendency to stick our chests out and say, "See what I have done," and forget that the part we individually play is a very small one. This has been especially true here in my case.

I am ever conscious of the great help I have received from the individual at the helm here at the Rome Air Development Center. Without that help I am afraid we would not have gotten very far in our research effort.

Our commander, Brig. Gen. Donald P. Graul, has been at once a counsellor, a patient and tolerant overseer, and a real friend, especially when the going has been a little rough.

It is my pleasure to introduce Brig. Gen. Donald P. Graul, the Commander of the Rome Air Development Center.

### BRIG GEN GRAUL:

I want to welcome all of you to Rome Air Development Center for this Second Conference on the Effects of Microwave Energy. While this is labelled on the program "Tri-Service," we are certainly happy to have all of those people working on the problem from the university field. This group is unique in that we have electronic scientists, engineers, and industrial medicine specialists. It is just recently that these two fields have been brought together in this way, and we will be looking to you people to solve these problems, or at least determine what the effects are and how we can avoid any harmful effects. As long as our equipment designers,

our component developers, go to higher and higher powers, we will have the problems we have today or increasing problems. With all of the people in this unique area here, I think we should finish the conference with a better understanding what is going on and what has been achieved so far. It is important to us who are developing this equipment to know the answers because the people using it in the field look to us for the measurements, possible effects, danger areas. In other words, they look to us for the answers, and we are hoping to get that out of conferences such as this and contracts that are now in effect. I hope, and I am sure, that this will be a very beneficial meeting to all of us. We are glad you are here.



## OUTLINE AND PURPOSE OF THE MEETING

by

George M. Knauf, Colonel, USAF (MC)  
Deputy Director of Applied Ecology  
Directorate of Technical Services, RADC

It certainly is gratifying to see so many of you here. We sincerely hope you find the material we plan to present both useful and thought stimulating. We have endeavored to put together a program which will first, be an up-to-the minute review of just where we stand in our research effort in the armed forces and second to couple with this research report certain data in allied fields which may be of some assistance in meeting everyday problems related to biological hazards. For the most part this span of material has been built around queries we have received from you since our last conference in July 1957. I am sure you all realize that it is difficult to restrict a program of this sort to purely biological subjects. There are many other considerations which must be built in to our approach.

The application of sound human engineering principles, a study of the value of shielding to our personnel protection plans, the education of operating personnel, all play an important part in the total effort. We have attempted to high-light these areas in our agenda. We will not belabor these topics but will just touch on them in order that you may know how the thinking goes at the moment in those fields. We will also be privileged to take a look at the long range plans in the area of Air Force electronic development. I feel this to be most important. It is extremely important that each of

have a clear mental picture of the ultimate goal of our investigative effort. When this program was first conceived at Rome, we limited our thinking to the problem of hazards that might result from exposure to this energy. Our effort was directed toward equipment in being at that time. We soon realized that this was a serious mistake. It became apparent that at least 2 or 3 years would pass before we were in possession of factual data relating to hazards that might arise from equipment already in the field. A quick look at the research and development program made it clear that by the time we had that data much of the hardware it applied to would have been made obsolete by a new generation of equipment. It was certain that we would remain 2 or 3 years behind the systems development program.

Obviously the development people were not disposed to take a holiday to allow us to catch up. Nor could we by-pass the urgent need for hazards data related to the equipment in use. The only apparent solution was to attempt to combine these two approaches. At about this time a new consideration appeared. A sputnik was launched. Of course our program was affected by the accelerated drive to get ahead with research. The word research had a new found appeal, a new charm. I am not going to comment further on this facet of our national philosophy which had so blithely set aside vital research endeavors at a time when the need was so great. As a result of this new interest in missiles and space, we found a completely revamped development program being born. The cry was for more power and more power. Research concepts set aside in the recent

past were taken down from the shelves, dusted off and given high priorities in the program. The emphasis was on new ideas, on a break through. Of course to those of us involved in the biological side of the work this meant real trouble. We were already behind. Ever since this program was born I have felt like a 3-year old trying to keep up with his father on a walk through the woods. Now it seemed that the task of keeping up with Dad was just about hopeless. But it had to be done.

We had no way of knowing just where the power output of the new equipment would fall, so we decided to extend the span of our investigation in such a manner as to try to accumulate some data in advance of an actual requirement for it. As a result we set out to do certain whole body exposures at levels as high as  $1.0 \text{ w/cm}^2$  of r/f power. This was modified in the case of selected organs to conduct exposures at lower levels where the energy could be concentrated on a tissue or body structure. Thus, in the case of the eye, exposures were conducted at about  $.3 \text{ w/cm}^2$ . It must be remembered that we had established arbitrarily a maximum safe exposure level of  $.01 \text{ w/cm}^2$ . Thus our experiments were tailored to power levels as much as 100 times greater than our maximum exposure level. You will remember that I have stated on many occasions that the most powerful radar set in operation today cannot produce this  $.01 \text{ w/cm}^2$  of power at 500 feet, even in the axis of the main beam.

Now when we looked at the whole research effort in its new setting it became obvious that it could not any longer be properly called a hazards investigation. We were truly looking at the broad

spectrum of possible microwave effects with a view toward being ready should our development people be successful in coming up with the higher power radar they were dreaming about. We dropped the word "hazards" from the title of our effort and replaced it with the word "effects." On this basis we have proceeded with the work you will hear about in the next couple of days. As you listen to these presentations of our research friends, be sure to bear in mind the two objectives of all of this work. We first are interested in any possible effect on man which might be produced by the power produced by radiating equipment in use today. Then next we want to get some idea what lies ahead biologically if we continue to increase the power output of our equipment. Of the utmost significance is the wide gap between the power we are operating at today and the levels at which we are conducting our probing exposures. Remember that the latter are many times greater than the capability of present day equipment. I think this might be a good time to say that up to date there has not been any effect produced or even hinted at at power levels which remotely approach our established maximum safe exposure level. An effect does not become a hazard until man is exposed to such an effect, and with the equipment of today this possibility is remote.

A few minutes ago I said you were safe in the axis of the main beam of today's radar sets at 500 feet. You must here again remember that to be a hazard, this axis of the main beam must be so located that a man can get into it. You can readily see that with tower mounted equipment operating at the usual angle of tilt, the

chance of getting into the main beam is rather unlikely. As a matter of fact, we find this possibility pretty well limited to our maintenance and operating technicians. Now that we have been able to delineate the hazardous areas around our gear, we have found it possible to devise protective measures which will adequately protect even those people. There seems virtually no possibility of an innocent passerby straying into the beam of existing equipment. Our current interest is in the new series of equipment on the drawing board at the present time. Here a certain number of these built-in safeguards are removed. We can be certain that we will attain power levels equal to our maximum safe exposure level over a much wider area. Such levels will not be restricted to the main beam. Because of the peculiar configuration of this equipment, it will be necessary for certain technical personnel to spend varying periods of time in areas where the ambient power level will exceed  $.01 \text{ w/cm}^2$ . However, the upward tilt of the beam will still be there, thus offering protection to the casual passerby. It is not appropriate at this meeting to go into details of this equipment. It is sufficient to say that the power of this proposed equipment is much greater than anything we have dealt with before. The problem of accidental exposure to this higher power becomes a possibility. The need for protective clothing to cope with certain operating and maintenance problems appears inevitable as does the need for more attention to shielding for buildings and passageways in the operational areas. Even here there does not appear to be any need for concern about any hazardous situation outside of the immediate vicinity of the equipment. It is

with the thought that we must be ready with answers for the questions that will certainly be asked, that we are going ahead with this forward looking research effort.

We had a meeting a couple of months ago attended by all of our principal investigators. At that time we feel we ironed out most of the technical details involving our research procedures. Some of the presentations you will hear are in fact the result of that meeting. I hope you will bear in mind that our purpose is to present to you certain data.

It is of vital importance that all of you be extremely cautious in discussing the data presented at this conference. It is essential that you clearly point out to your listeners the fact that our results cannot be tied to today's equipment. You must remember that this subject has an enormous public appeal and lends itself readily to sensational headlines in the press. I know. We are presenting the whole story honestly and factually in keeping with our promise of last year. This is done because we feel that a technical group such as this will be able to accurately interpret the results of our work in terms of hazards. We feel this group represents the folks who have a need to know what we are learning. This might be looked upon as a report to the stockholders. Use it wisely--please do not betray our confidence.

**PHYSICAL CHARACTERISTICS OF MICROWAVES  
AS RELATED TO BIOLOGICAL EFFECTS**

by

Dr. Joseph H. Vogelmann, D. Eng., RADC

COLONEL KNAUF:

No single facet of this whole problem of microwave effects seems to cause more confusion than the questions which arise out of the failure to understand the physical characteristics of this energy and how it differs from ionizing radiation. In the hope that we might get our feet on solid ground right from the beginning we have asked Dr. Joseph Vogelmann, the Technical Director of our Directorate of Communications, to discuss the physical characteristics of microwave energy as they are related to our problems in the biological area. Dr. Vogelmann is a nationally recognized authority in the field of microwave theory. I might add that he has been of invaluable assistance to me in my management of this work. I am sure that we will all profit by the information he has for us this morning.

DR. VOGELMAN:

Initially, let me outline the differences between what I am going to talk about and what someone would talk about if he were talking about X-Ray. Basically, the difference is in measurement. In the case of microwave energy, we measure the power it takes to generate the field. In the case of X-Ray, we measure the effects of the field. When you are talking about roentgens, you are talking about the ionization that is produced by the field. This is a different kind of a number. It means something different in terms of power when you talk about short X-Rays as compared to long ones. Now, in the case of X-Rays, we have been measuring the radiation effect. In fact, all the measuring instruments measure effect. In the microwave case we talk about the power generated, the strength in the field, and not its effect. This makes a significant difference. It is not the current

that you generate in the X-Ray tube that is determining the amount of energy, but the fact that shorter wave lengths take more power to create in the first place. Now that I have made these general comments, I will discuss only the microwave cases.

Let me first introduce you to some basic concepts of frequency and wavelengths. The first concept which has importance in the effect of radiation of the microwave case is the frequency. It is actually the wave length that we are talking about, although these two are related. The thing I want to point out is that the shorter the wave length, the higher the frequency. This is the same thing that you find out on a violin or on a piano, the short strings make the high notes and the long strings make the low notes.

<u>FREQUENCY</u>	<u>WAVELENGTH</u>
LOW FREQUENCY	LONG WAVE
HIGH FREQUENCY	SHORT WAVE
SUPER HIGH FREQUENCY	MICROWAVE

In the frequency column above, if the frequency is low, we have long wave lengths. If it is high frequency, we have short wave lengths. If it is super high frequency, we call them microwave-wave lengths.

Let us look at the effect of the wave length (Figure 1). Each one of these balls corresponds to a wave length. The obstacles correspond to the physical characteristics. These characteristics have various parts. First they have bumps. You will see big bumps and smaller ones. Secondly, they have physical properties which in the electric case would be dielectric constants, resistivity, and



permeability. These are equivalent to determining whether obstacles are made of rubber, steel, or rock; so if this is made out of rubber, it absorbs all the shock and all the energy is transferred into the rubber. If it is made out of something that is very hard, such as rock, it absorbs very little of the energy and most of the energy is used to kick them off somewhere else. All these properties have a significant effect. You see the large ball keeps going in spite of the bumps because they roll over them. There is not enough energy removed from the large ball by the small bump to be significant, so that they keep going out of the picture. The medium size wave lengths get trapped part way through the material and the very small ones get trapped almost immediately.

Let us look now at some numbers.

<u>FREQUENCY</u>		<u>WAVELENGTH</u>
1,000 KC/S	-	300 METERS
100 MC/S	-	3 METERS
10,000 MC/S	-	3 CENTIMETERS
1,000 KMC/S	-	300 MICRONS
100,000 KMC/S	-	3 MICRONS

A thousand kilocycles corresponds to three-hundred meters. As a rule of thumb, an obstacle ought to be at least one-tenth as big as the wave length. So if you are talking about a thousand kilocycles to get a significant effect, it ought to be at least thirty meters long. I do not know any people thirty meters tall, so they are reasonably safe. Let us look at a hundred megacycles. It is three-tenths of a meter, thus a man becomes significantly tall at a hundred

megacycles. Ten-thousand megacycles corresponds to three centimeters. We are talking now about three-tenths of a centimeter as being significant. Here individual components of an animal or human being become important. In addition, the penetration through the individual is also significantly reduced. This penetration can be considered to be in the order of something like a hundredth to a tenth of the wave lengths in ordinary flesh. You can expect that on the average penetrations of a three-hundredth to three tenths of a centimeter. Now when we get up to a hundred-thousand kilomegacycles, we are talking about three microns (three millionths of a meter) wavelength. That penetration is about the same as one layer of skin and when you get out beyond the infra-red, only the top of the skin is penetrated. If you go lower to the ultra-violet, just the top layer of skin gets burned and nothing else happens, at least if you don't get sick with some other side effect. The things that are important are the amounts of microwaves, i.e. the microwave energy present, the amount reflected, and the amount transmitted through the object. It does not matter how big the field is, rather the amount of absorbed energy. If you are talking about biological effects, you are considering the skin, the muscles, and various constituents of the body. One thing of importance is size. A second is the loss in power. If the object has absolutely no microwave power loss, the energy just goes through as if the obstacle were not there. Material like polyfoam has this characteristic. A third important effect is the interface effect. Every time you go from one material to another, this change or discontinuity produces a re-orientation of the power.

Let us look at this discontinuity. Figure 2 illustrates a curb on a street corner. If we have a bunch of balls coming down, (the ball size is still wave length) the big ball meeting this discontinuity bounds over and loses some of its energy. The small balls, on the other hand, come along and they hit the curb and bounce back. If there are enough balls coming from the left end, eventually some of them get over, but there is a big pile up on the left side of the discontinuity. If the speed of the balls is just right, some of the balls coming from the left will meet some of the balls bouncing back. Since they both have exactly the same amount of energy, you get a big pile of balls in the middle. In electro-magnetic terms, this is the standing-wave phenomena which is very important. If you are talking about the power that is absorbed in this area, you will find that there is much power here but very small amounts on either side of it. It turns out in fact that after the discontinuity itself, you may have no power absorbed or reflected back. Three things are important: how much power is transmitted through and how much power is reflected back, and where it is lost.

Let us look at the next phenomena--resonances. I originally recommended that we subject all the biological specimens to all frequencies on a continuous basis, because I know of some ten-thousand different resonant frequencies for different materials which have been tabulated by different physicists over the last ten years. Thus, if you pick the right material, you can get a resonance at any frequency. Economics persuaded everybody that they ought to do it at a limited number of frequencies and not try to find all the

resonances. There are two important resonances. The first is the dimensional one. If the object is a specific part of a wave length in length, it will build up the maximum energy in the middle of that object. The second resonance which is important is inherent to the makeup of the material--molecular, electron, and nucleus. The molecular resonances result in movement of the constituents of the molecule in such a manner as to stretch the bonds between them. If you put in enough power, you can make the molecule break up and form different molecules. The electrons that spin around the nucleus also resonate. Finally, the nucleus itself resonates. It orients itself with respect to the field. These three resonances are inherent to the material.

The first resonance I indicated is innerent to the dimensions of the material. Those people who remember the Model T will know that the bumps in the road were always about as far apart as the two rows of wheels and that the car would go up and down on a continuous basis. This is strictly a dimensional resonance, having nothing to do with the properties of the Ford, but with the spacing between the bumps in the road. With new cars we go very fast; the spacing between the bumps is still significant. However, we reach a point where the natural resonance of the springs in the car take over. If you have driven with a shimmy, you can realize that when you get up to speed it gets worse and worse as it absorbs more and more energy from the road with bigger and bigger bounces. This is a resonance due to the material.

Now let us look at some of the problems in the antenna.

### ANTENNAS - BEAM FORMING

NEAR FIELD

FAR FIELD

REFLECTIONS

Insofar as biological hazards are concerned, the only significant place for microwave energy is the output of the antenna. There are three contributors that comprise it. One is the near field. That is the region where the beam has not yet formed. There is a near field for every antenna which depends on the size of the antenna and on the wave length. There is the far field where the radar beam is formed and where the energy falls off as the inverse square of the distance. The third is reflection. Because of the presence of objects within the vicinity of the antenna, and in spite of the fact the antenna may be looking in another direction, you get energy reflected in various other places in such a manner that they may add in some places and subtract in others. Thus, you can have large energy away from the main beam in some cases. On the other hand, much closer to the main beam, you will find no energy at all.

Let us look at our antenna beam (Figure 3). The antenna beam is made up of a feed horn which feeds energy to the reflecting surface and the reflecting surface hits the energy back in all sorts of direction. Every small section of the antenna aperture has to feed back energy in a small quantity in generally the right direction. Some of it escapes and goes out in other directions. Beyond this region there is incoherent beam. It may have maxima or minima at

different places. The energy is spread out over the total width of the aperture and stays within this width in the near field. At some given point the beam starts to form. Where the beam starts to form is where we define the far field. This region we call the near region. Once the beam forms, it maintains the same shape, but it drops in energy with distance. It gets wider and wider and as a result the energy per unit area goes down. The important thing is that you cannot use the standard formulas in the near fields for determining whether there is or is not a hazard.

The thing that you want to know is how much field there is in any specific place. Basically, when you measure the field strength, you are not determining whether there is a hazard or not; you are determining the likelihood of there being a hazard. I pointed out before that there are the important things that you must consider. First you have to consider the fact that the object must be at least of significant size compared to the wave length. If you have a field strength of a tenth-hundredth of a watt/cm<sup>2</sup>, but if it is at a wave length which is three hundred meters, it does not really make any difference. Secondly, you have to find out how much of the energy would be absorbed. If the body happens to be transparent to this wave length, then it is not significant what the field strength is either. Thirdly, you have to know how much of the energy is reflected. Energy is reflected from all kinds of interfaces. What we are doing in this measuring technique is telling you what the opportunity for the existence of hazard is. The way to do this is very straight forward. We use standard Air Force power meters and calibrated antennas and we tell you that the field strength, the total

amount of power that exists at any given point, is so many hundredths of a watt/cm<sup>2</sup>. This says there is the opportunity for the existence of a hazard at this point. The standard technique that has been used here is very effective and will give you the answer you would need for determining whether there is a hazard.

The figure below serves as a reminder that the power absorbed is the power that is of interest in the microwave hazards program.

**POWER ABSORBED =**

**INCIDENT POWER LESS REFLECTED AND TRANSMITTED POWERS**

The incident power, i.e., the power that you measure with the power measuring equipment, (thus the power absorbed), is the incident power less the reflected and transmitted powers. If energy comes out the other end, it does not affect you. Also if it is reflected from the skin, it does not affect you. Now, basically, the thing you have to determine, to establish whether there is a hazard, is how much power is absorbed.

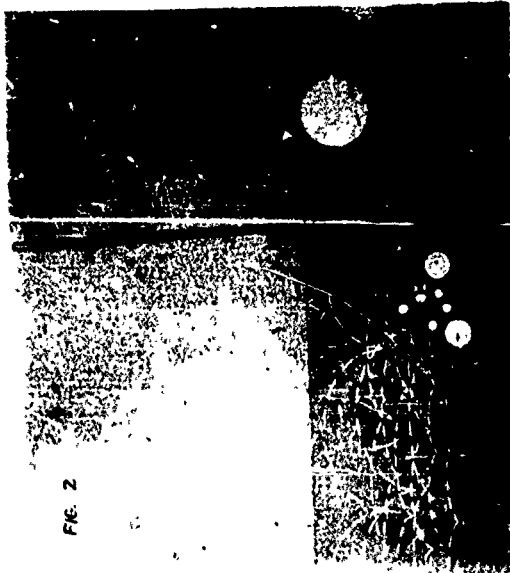

FIG. 2

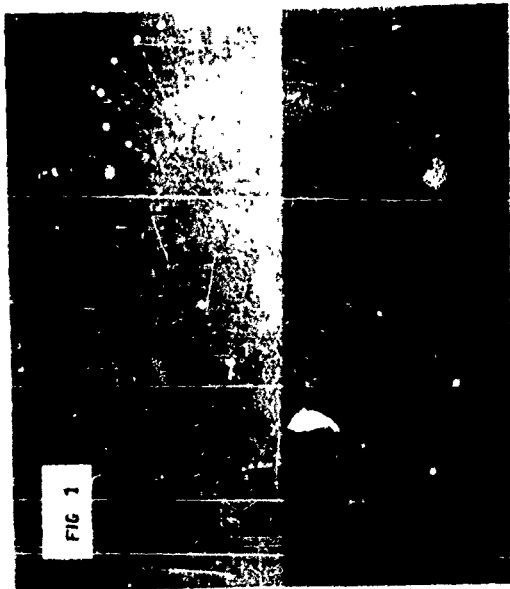

FIG. 1

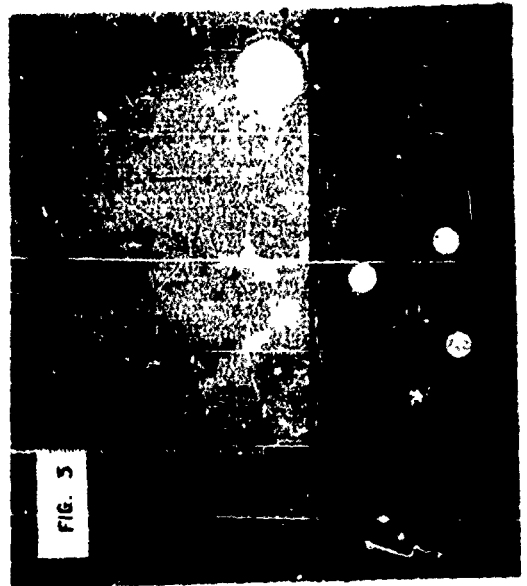

FIG. 3



DISCUSSION OF LONG RANGE DEVELOPMENT PLANS  
IN THE AIR FORCE

by

Harry Davis, Scientific Director, RADC

COLONEL KNAUF:

Seldom does one have the good fortune that has been my lot at Rome. Here I have found patient guidance and tolerant instruction at the hands of a group of people already pressed by the magnitude of the task ahead of them.

Foremost among this group with whom I have been privileged to associate is Mr. Harry Davis. Mr. Davis is the technical director of the Rome Air Development Center. His is the task of maintaining some semblance of scientific order in this bag of worms which results from the frenzied progress which marks the field of electronics. Mr. Davis has never been too busy to spend time answering my questions, never unwilling to stop and patiently explain how I happen to be going the wrong way on a one way street. Too he has endorsed my work when there has been a question as to whether we should continue.

Mr. Davis, of all individuals in the Air Force, is best fitted to discuss with us the future of higher power electronics in our field. As a matter of fact, he decides to a great extent where the Air Force might best apply its electronic research resources.

MR. DAVIS:

What I would like to do first is to review just very briefly what Dr. Handelsman presented last year and then go on to some of the things we discussed, some of these unclassified things which were discussed at a space symposium held recently at Wright Field and which represented Air Force thinking. The only picture of a frequency diversity radar which was unclassified was the one which is called the AN/FPS-26--one of a new family of radars. It is a height finder radar. Radars in this new family may have from 10 kilowatts of average power to 70 kilowatts of average power which

is quite a lot (Figure 1). This gives an idea of what this radar looks like. We have a tropospheric scatter communication set which radiates around 10 kilowatts of average power. The new generation of these communication sets will radiate around 100 kilowatts of average power.

What we'd like to do is show quickly the present radars, the present communications and where we are going from there and what type of power we are dealing with.

Let's have a brief review. The next two slides are entitled "How to be a Design Engineer in Two Easy Lessons." I suspect that we needn't dwell on this, since last year's minutes contain Dr. Handelsman's notes and Figure 2 is the diagram taken from these minutes. With these data, you can quickly calculate the power densities, both in the waveguide shown at the bottom or in the feed shown in the middle of the slide.

Figure 3 again points out some highlights of Dr. Handelsman's talk. One is concerned with three regions in space when considering the radiated power problem; that is, the Fresnel zone or near field region. The Fresnel region extends over a distance equal to roughly one quarter of the diameter of the antenna squared divided by the wave length. The same linear units, inches, feet, meters, miles are used. The next region is the cross-over region where you are neither in the Fresnel region or in the far field. In each of these regions there are indicated on the slide rough equations which give values for the power density. These may be dangerous. They really give an average value; they don't give you peaks.

Table 1 below (presented last year) is a cross section of the magnitude of power which we are dealing with at the different frequencies, the average power and the power densities at the feed.

TABLE I

<u>Frequency</u>	<u>Tube</u>	<u>Peak Power</u>	<u>Average Power</u>	<u>Power Density</u>
9200 mc	Magnetron	0.75 MW	0.75 KW	234 watts/cm <sup>2</sup>
5400-5900	Klystron (T)	3.0 MW	3.0 KW	303 "
2700-2900	Magnetron	5.0 MW	4.5 KW	155 "
	Magnetron (T)	3.5 MW	3.5 KW	120 "
	Klystron (T)	5.0 MW	8.0 KW	276 "
1250-1350	Magnetron	9.0 MW	10.0 KW	86 "
	Klystron (T)	2.0 MW	6.0 KW	52 "
	Klystron (T)	10.0 MW	15.0 KW	129 "
400-450	Triode (T)	5.0 MW	300 KW	212 "

Concerning the scanner used in the detection of ballistic missiles, Figure 4 illustrates the Torus Scanner. It is so called because the reflector has the shape of a torus.

Figure 5 shows another type of radar also for missile detection--the AN/FPS-17. This one is at Laredo, Texas. It emits about a 100 kw of average power while the "Torus" is about 600 kw.

Figure 6 shows a tracker. This tracker radiates about 600 kw. It will be installed down range.

Now proceeding into a longer time scale, we are going to start playing around with communications by satellites (Figure 7). And, I think that you all know that if we had a satellite twenty-five or twenty-six thousand miles from the center of the earth, it would

stay fixed relative to any position on earth. In other words, if the rate of rotation corresponds exactly to the rotation of a point on the equator, of course, it would be rotating in the equatorial plane; and if we had three such satellites, 120 degrees apart, almost all of the earth could get communications at all times by sending the message to these satellites which would then be radiated back. We can have several types of re-radiations, either an active type which has active transmitters in the satellite or, as illustrated in the corner, we can have a corner reflector, a cluster for instance. The power just hits the satellite and bounces back. Thus, no batteries are necessary in the satellite.

Now, we are going to quickly switch between radar and communication (Figure 8). Here is the type of calculations that get a design of a radar of twenty-five thousand miles. Incidentally, the AICEM was a 2500-mile radar. We are going to twenty-five thousand, very quickly, in two or three minutes; but, again, we find we are getting most of it not by increasing the power so much but by having a bigger antenna. You note that the power is only 250 kilowatts and we are requiring an antenna 3000' by 3000'. Notice the configuration of that antenna having individual dipoles with transmitters connected to each one. This is called a "phased-array-type antenna," and it is very interesting because, with conventional antennas, you have the power density right in front of it. This is your most dangerous region. Well, not with these phased arrays. They will emit power in any direction, so that there are dangerous radiations possible in many directions from a fixed antenna.

Now, we are graduating from the earth and earth satellites to planets (Figure 9). Here we have the planets of most interest for the immediate future. We are dealing primarily with Mercury, Venus and Mars and here are the average distances. Notice that they are all in one plane, the ecliptic. This is the plane of most strategic worth as far as we are concerned.

Now we will add some quick calculations on what it would take for a radio set to communicate between earth and the planets. Figure 10 shows that we are arriving in the region of a million watts. Notice  $10^6$  down at the bottom of the graph. To get the corresponding distances, we observe the vertical scale, thus see the distance of Mercury as shown; the sun is the top dotted line. Here is Mercury, then Mars, then Venus. With different receiver sensitivities, we can get the power required.

If you want to have an inter-planetary radar set, you can see in Figure 11 that we are talking about peak powers of about a thousand megawatts, with ten seconds of integration and average powers of about one hundred megawatts.

Let's have a look at our galaxy (Figure 12). This would be the next goal in our long range planning. From the center of the galaxy, the sun is set off about 27,000 light years. This is the magnitude of distance over which we may want to communicate.

Again we ask--how can you communicate over these distances? Most of the available spectrum is shown in Figure 13, and there are just a few "windows" or a few frequencies where we actually can get out. One window is the optical one. The other window is the radio

spectrum, which is much broader than the optical window. In between we are pretty much in the dark as to what we can observe in outer space.

If we wanted to communicate interstellarwise, we have some predictions in Table 2 about what we can do. In 1965, we should have 10 megawatts peak at 10,000 megacycles for the antenna area illustrated for receiving and transmitting. With such equipment, we can get 25,000,000,000 miles communications or  $4/1000$ 's of a light year. By 1975, we estimate that we can get 10,000,000,000,000 miles or 1.76 light years, enabling us to send one bit per second. Incidentally, this doesn't do you much good since the nearest star is four light years away. Who wants to know what happened four years ago? That's the situation, if you did want to do this. The question is - why send information that fast if the information returned is four years old?

TABLE 2

INTERSTELLAR COMMUNICATION

1965: 10 mw peak,  $f = 10,000$  mc, Transmitting and Receiving Area -  $100 \text{ m}^2$

J = 10 Microseconds BW - 0.1 mc NF = 8 db Losses 9 db  
R = 25 Billion Miles = 0.0044 Light Years

1975: R = 10 Billion Miles = 1.76 Light Years  
(Why 1 bit/second?) (Nearest Star 4 Light Years)

(The next page will be 25)

	1965 Range (Million Miles)	Region Covered From Earth (1965)	1975 Range (Million Miles)	Region Covered From Earth (1975)
Omnidirectional Transmission & Reception	10.5 Voice 18 Code*	Insufficient for Interplanetary Communication	400 Voice 700 Code*	Mars Venus Jupiter
Beamed Trans & Reception (Antenna Areas = 100m <sup>2</sup> )	1,500 Voice 3,000 Code*	All Solar System	60,000 Voice 320,000 Code*	All Solar System

\*Code at 100 Bits per Sec.

Table 3 lists some radar improvements which are necessary before we can have a radar instellarwise. For example, here we are considering a thousand megawatt peak, sixty megawatt average, and possibly twenty thousand megawatts by pulsed nuclear reactions.

TABLE 3

IMPROVEMENTS IN DETECTION	(490-MC RADAR)
Power: 1000-MW Peak: 60-MW Avg. (20,000-MW by Nuclear Pulses)	20 DB
Receiver Sensitivity: Lower Noise Figure Low Temperature	1 DB 10 DB
Antenna Gain: From 10 <sup>4</sup> to 10 <sup>6</sup> (Phased Array)	20 DB
Pulse Compression: 1000 to 1	0 DB
Signal Processing: From 6 DB to Theoretically Perfect	6 DB 57 DB
100,000 Miles on a 0.1 Sq. Meter Target	
1,000,000 Miles on a 100 Sq. Meter Target with a Maser-Receiver	

Thus, we have a review of our present radar systems and what may be possible in interplanetary and interstellar communication in the future.

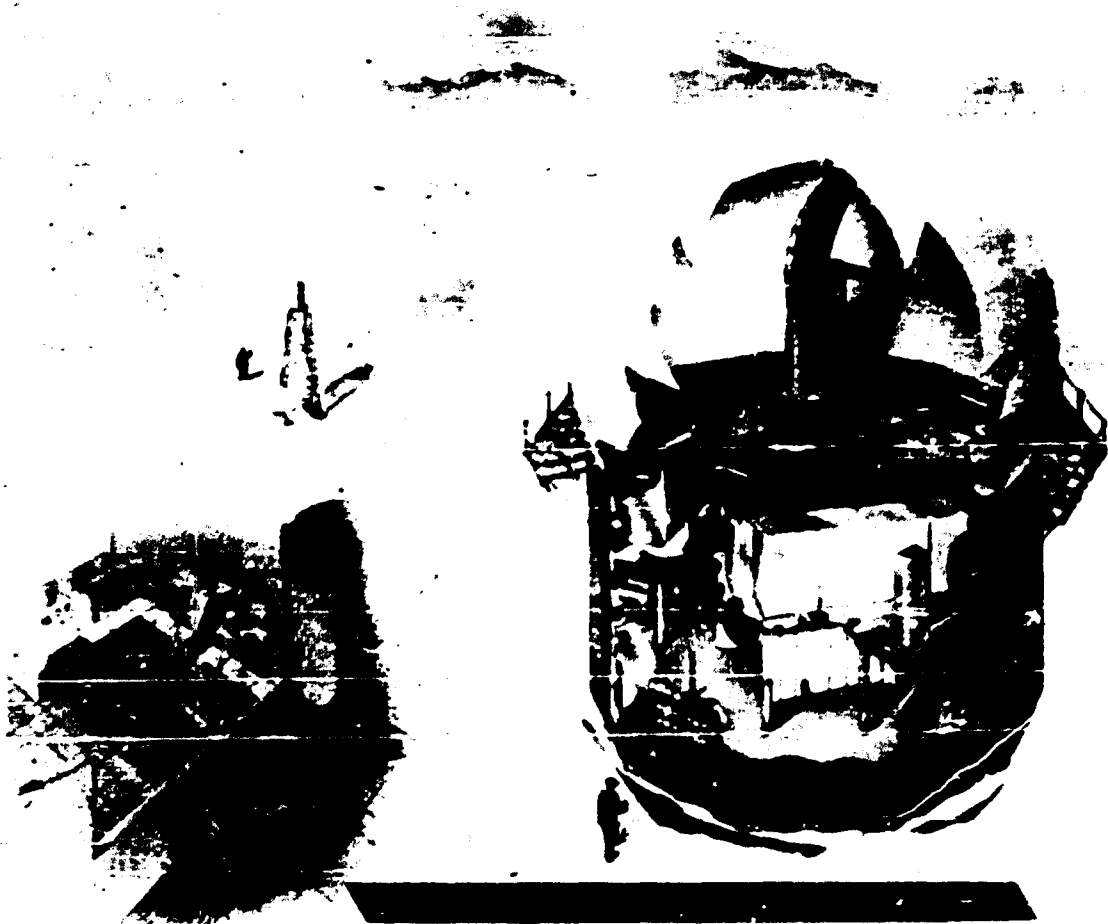
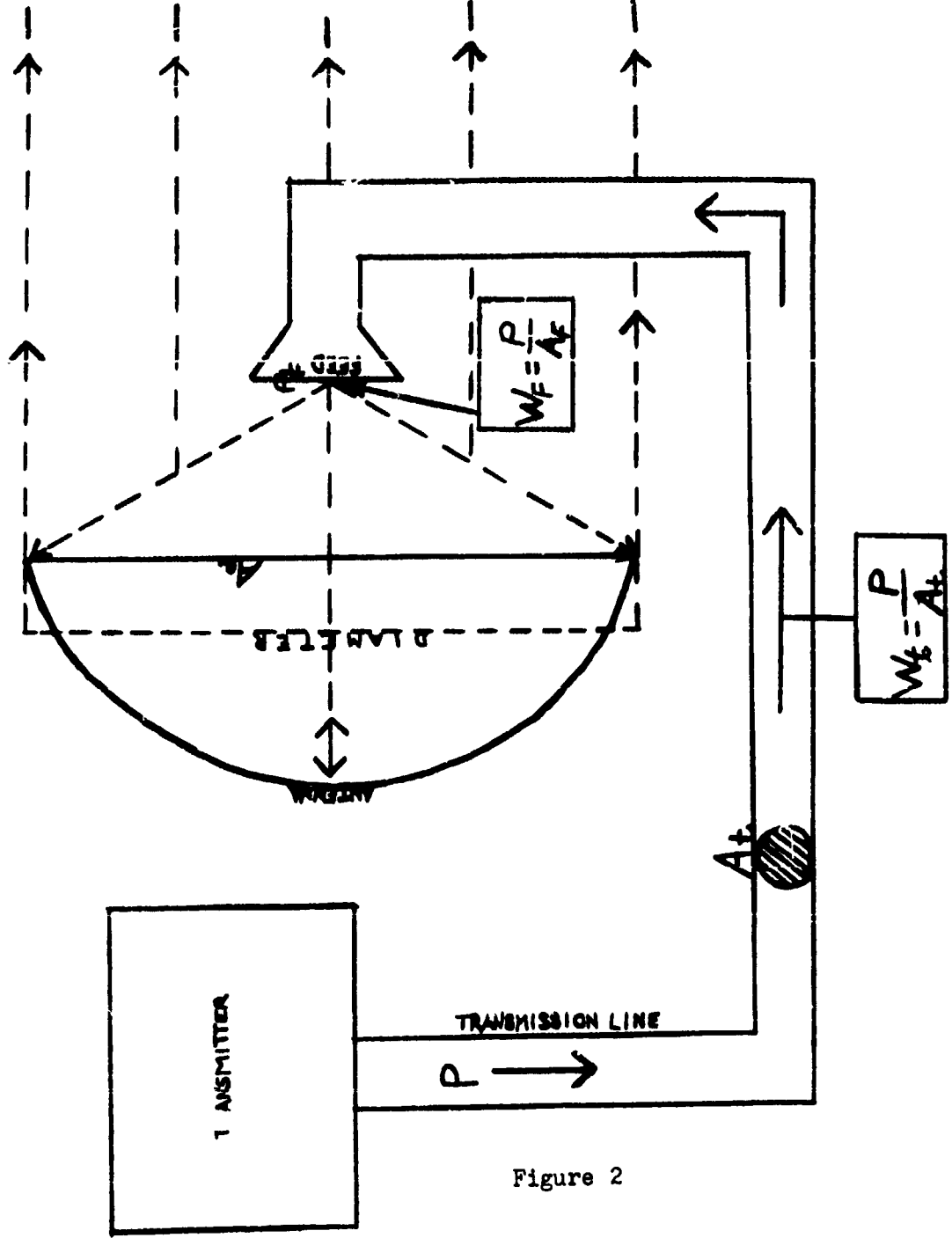

Figure 1





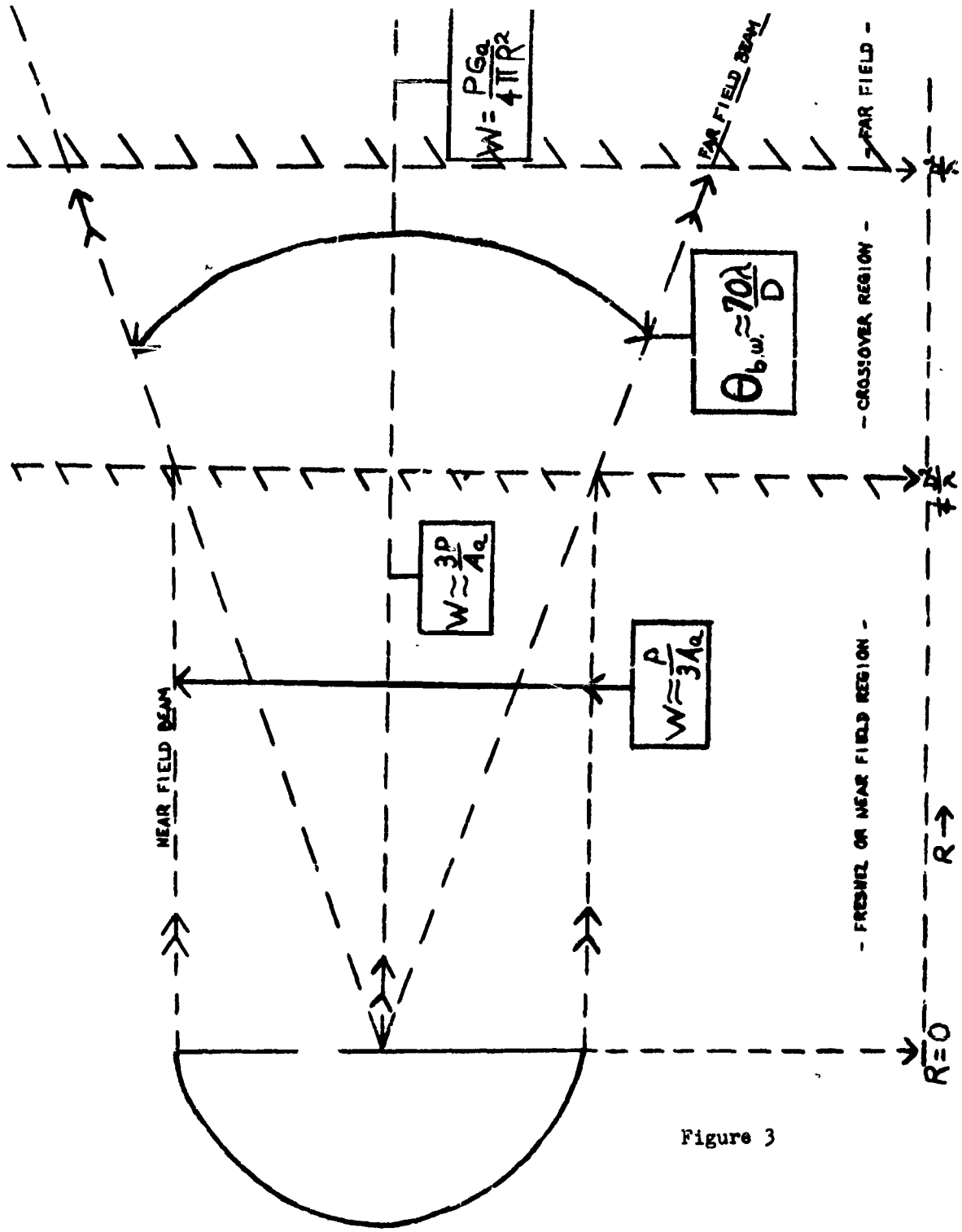

Figure 3

# TORUS SCANNER

- POWER -- 10 MW PEAK -- 600 KW AVG



- REFLECTOR -- 165' x 350'
- FEED -- ORGAN PIPE SCANNER
- BEAM -- 1' x 1'
- USE WITH FPT-2 & FPT-5 TRANSMITTERS

FIG. 4

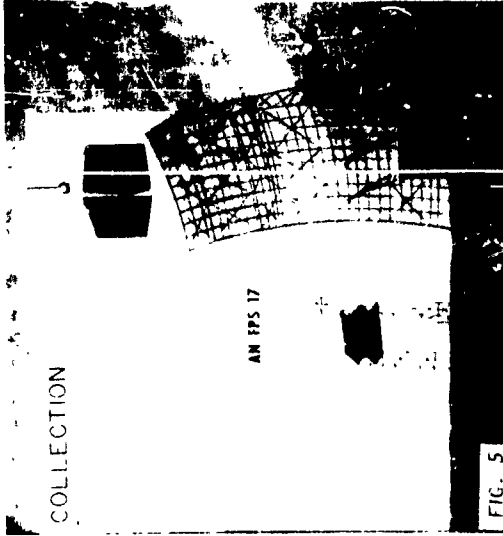

FIG. 5

# DEBRIS ANALYSIS TRACKERS

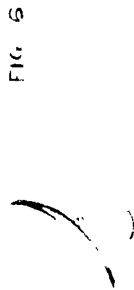
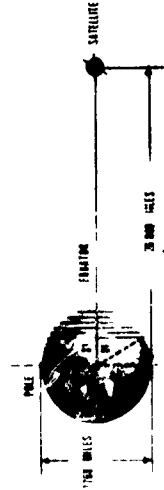

FIG. 6

- MOUNT -- MILLSTONE-LIKE
- DISH -- TO HIGH FREQ. TOLERANCE  $F_D$  FOR MONOPULSI
- BEAM --  $< 2^\circ$
- POWER -- FROM AVAILABLE TRANSMITTERS
- FREQ. --  $\approx 4.50$  Mc.  $\approx$  MUCH HIGHER

# COMMUNICATION VIA EARTH SATELLITES



- 3 SUCH SATELLITES 120° APART ARE REQUIRED -- ALMOST ALL EARTH PASSIVE -- LONG LIFE -- EASIER PROPULSION
- ACTIVE -- LESS POWER ON EARTH



REFLECTOR ANTENNA

FIG. 7

# RADAR SET TO VIEW EARTH SATELLITE

$R = 25,000$  MILES

$A_G = 10^5$  (3000' x 3000' ANTENNA)

$\Delta f = 100$  mc BAND WIDTH (EFFECTIVE) = 0.1

$A_R = 3' \times 4'$  (RECEIVER ANTENNA)

$P_T = 250$  kw



Figure 8

## OUR NEW ENVIRONMENT

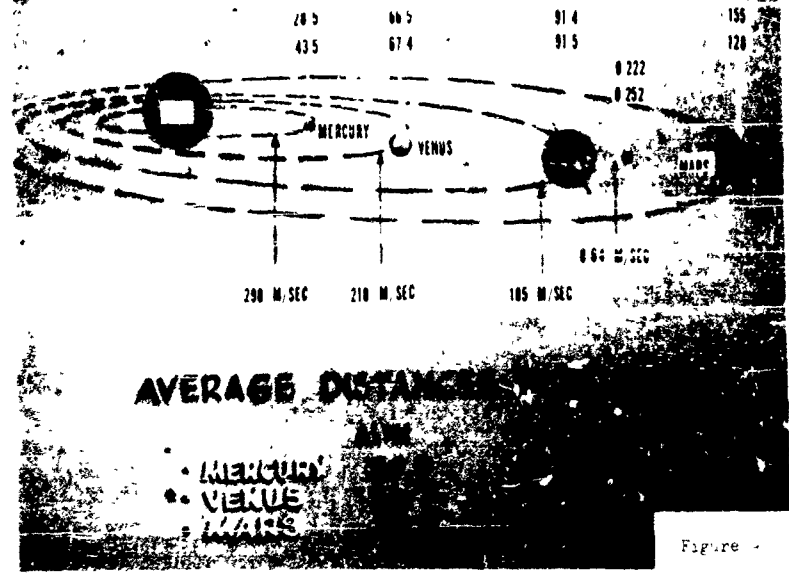

Figure 9

RANGE OF ONE WAY RADIO AT 50 MC

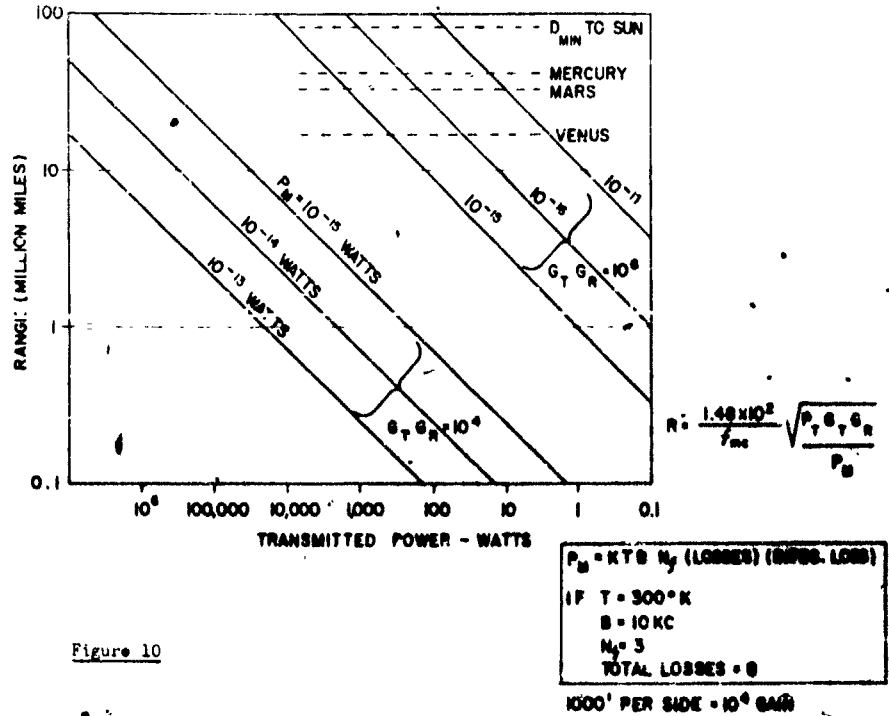

Figure 10

# INTERPLANETARY RADAR SET

RECEDING SET AT 100,000,000 MILES  
 REQUIRES 250,000 MEGAWATTS  
 SPACE VEHICLE-BORNE RADAR  
 "VIRTUAL" ANTENNA  
 = 1000 MEGAWATTS FOR 10 SECONDS  
 = 100 MEGAWATTS

EARTH MOTION 185 M/SEC  
 1850 MILES  
 10 SECONDS LATER  
 EARTH

Figure 11

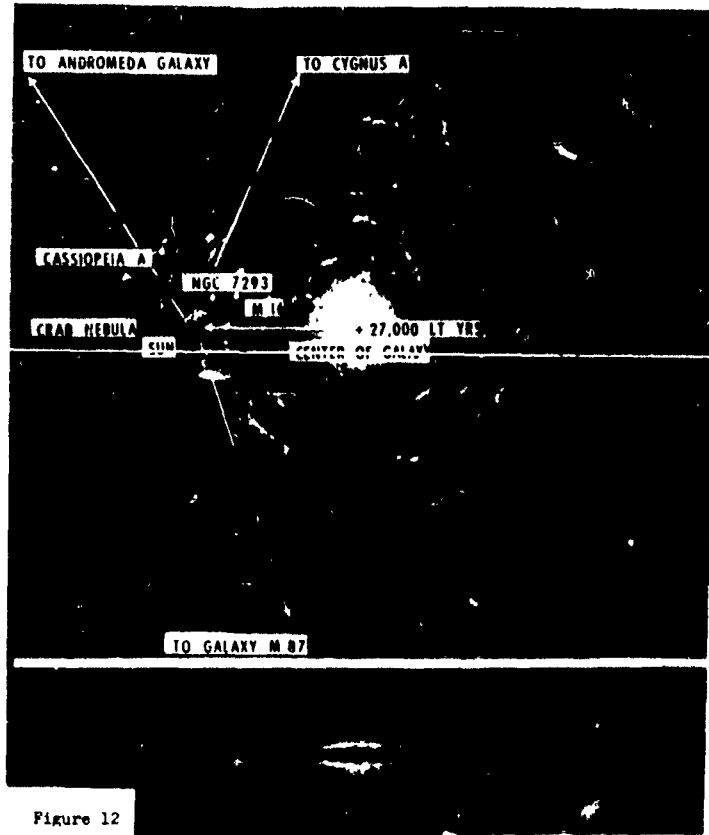

Figure 12

## OUR GALAXY

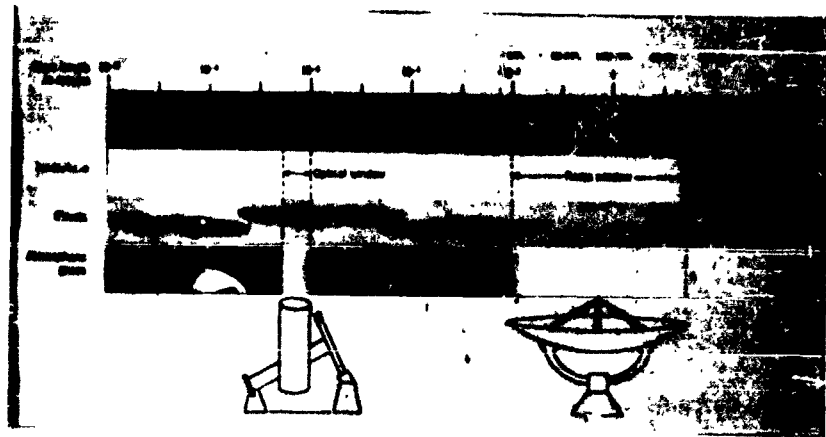

Figure 13

## OUR CONTACTS WITH OUTER SPACE

MOLECULAR RESPONSE CHARACTERISTICS  
TO ULTRA-HIGH FREQUENCY FIELDS

by

Herman P. Schwan, Ph. D.  
Electromedical Laboratory, University of Pennsylvania

COLONEL KNAUF:

The next speaker I am sure needs no introduction to many of you. One cannot go far in a study of the field of microwave effects without being impressed with the many valuable contributions to our understanding of this area made by our good friend Dr. Herman Schwan of the University of Pennsylvania.

Dr. Schwan has assisted us in our work in two ways. He is the principal investigator on one of our research contracts and has been a valuable counsellor and proctor for me.

He is here today to talk on a subject of vital importance in the field of microwave effects. Tomorrow he will talk on the progress of the work under his contract. It is always a pleasure to hear Dr. Schwan.

DR. SCHWAN:

At present, research on the effects of electromagnetic radiation is of a thermal nature. Nothing has been reported which proves clearly or indicates strongly the presence of nonthermal effects. This, however, does not rule out their existence. It might be that the present techniques are inadequate to recognize them.

Two facts appear obvious. First, it would be difficult to trace nonthermal effects in animal experiments where one studies the results from exposure since no thermostat could be constructed to keep the temperature throughout the body at a normal level and thereby exclude thermal effects. Also, the variability of animal responses is sufficiently high to make it difficult to establish

very exact relationships between dose and effects. Such relationships are, however, a prerequisite for establishing the existence of any nonthermal components.

Second, if nonthermal effects exist, they will probably be explained on a microscopic, submicroscopic or molecular level. This follows from the uniform, unspecific manner in which electromagnetic waves have been found to propagate through all types of tissue. From our analysis presented later and in the summary, it is apparent that in the radar frequency range tissues are really protein solutions; i.e., electrolyte solutions in which are suspended individual protein molecules and protein lipid complexes such as are found in cell membranes and the cytoplasm of tissues, nerves, etc. Any other effects than thermal responses resulting from the dielectric and ionic properties of electrolytes must, therefore, originate with dielectrically distinguished protein and protein lipid complexes.

What molecular and subcellular mechanism could in principle establish nonthermal effects? There are two distinct possibilities which merit consideration. However, before we are able to assess the likelihood of either or both of them taking place, the dielectric properties of tissues should be summarized on a microscopic level. The following figures serve this purpose.

Suppose a voltage pulse is applied to a tissue complex or a suspension of cells, bacteria or erythrocytes. This situation is shown in graph A of Figure 1. Upon application of constant potential to the suspension, the total charge jumps immediately and is then observed to continue to rise slowly until it achieves a constant



value. This is depicted in graph B and is characteristic of all types of tissues and suspensions of biological particles and, as a matter of fact, most other substances.

Whenever such time behavior of charge accumulation as shown in Figure 1 exists, then variation of the frequency must cause the dielectric constant and conductance to change in an S-type pattern (Figure 2). This follows from a simple mathematical argument. As the frequency increases, the dielectric constant falls off and the conductance increases from one constant level to another. This effect is known as a dispersion phenomena. Any material with the above mentioned time characteristics demonstrates the property of dispersion.

Figure 3 attempts to analyze the mechanism responsible for the dispersion behavior of tissues. In biological cells it must be taken into consideration that the cell membrane exhibits a rather pronounced capacitance, but very low resistance. Hence, when the tissue is exposed to an electrical current, the total current splits up into two principal parts. Part of the current bypasses the cell and passes through the electrolytes surrounding the cells (specific resistance  $\rho_{\text{sub-a}}$ ), and the other part will pass through the cell membrane and into the interior (indicated by the specific resistance  $\rho_{\text{sub-i}}$  in the circuit). When the total effective capacity and conductance of such a circuit is calculated, the frequency dependent dispersion behavior results. This merely reflects the fact that the capacitive cell membrane imposes on the current a frequency dependent reactance, and therefore the ratio of the two currents, passing and bypassing the cells, must also vary with frequency. It is

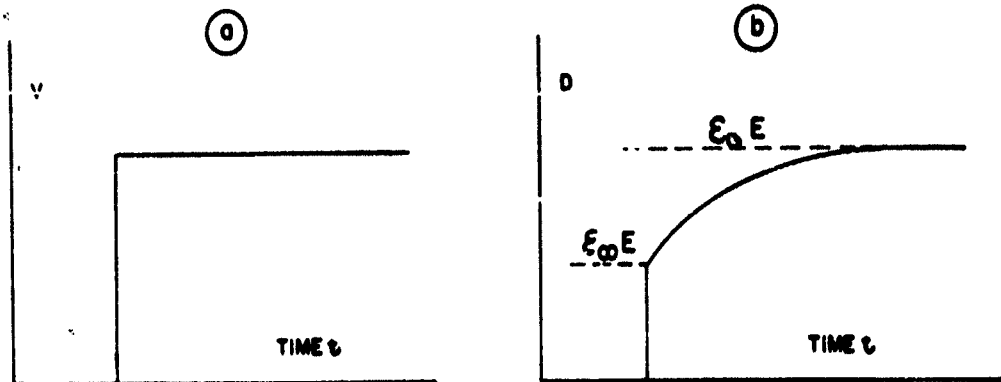

Fig. 1. Transient behavior of displacement (charge per unit area) if a step function potential is applied to biological material and tissues.

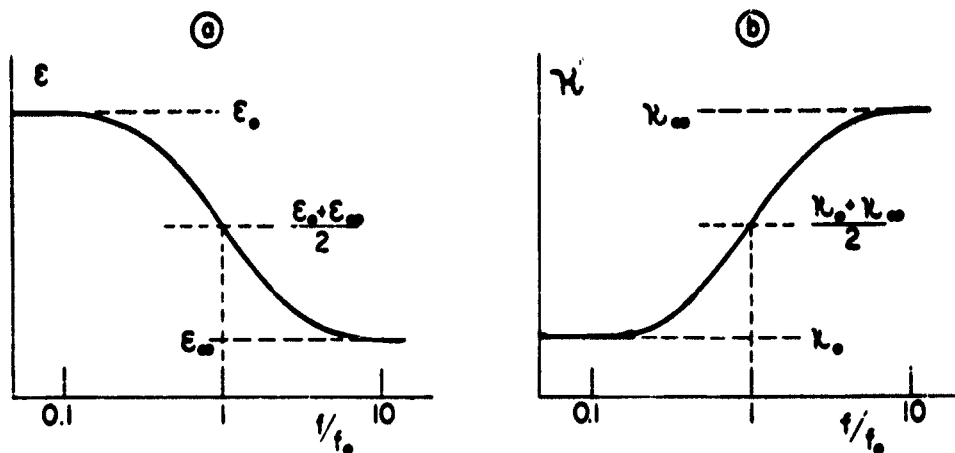

Fig. 2. Frequency dependence of dielectric constant  $\epsilon$  and conductivity  $\kappa$  corresponding to the time domain behavior shown in Figure 1.

apparent that at sufficiently high frequencies the membranes "disappear," since their reactance vanishes and that at very high frequencies tissues appear as if they had no cell membranes; i.e., as electrolytes containing proteins.

The above outlined theory has been developed in great detail. Figure 4 pertains to a suspension of erythrocytes and illustrates the success of the theory by the excellent agreement of theory (solid curves) and experimental points.

The curve in Figure 5 indicates the behavior of *B. coli*. Bacteria have a quite similar frequency behavior. The two chosen examples illustrate that above 10 mc the dispersion comes to an end; i.e., that they represent in the radar range the case of "disappearing" membranes outlined above.

In Figure 6 muscular tissue was chosen to represent all tissues. Included here is the dielectric constant of muscle over a very broad frequency range. When measuring from 10 to 10,000 megacycles, three, rather than one S-type curve (alpha, beta and gamma) result. The beta curve and its mechanism was discussed in previous figures in more detail, and the alpha curve is of no concern since its frequency range centers around 100 cycles. On the other hand, the gamma curve warrants attention because of its location in the radar frequency range. Its major fall-off is explained by the water content of tissues since water and electrolytes are known to display a dispersion centered around 20,000 mc. However, the continued and slow change between beta and gamma dispersion is not explained by water proper and discussed in more detail now.

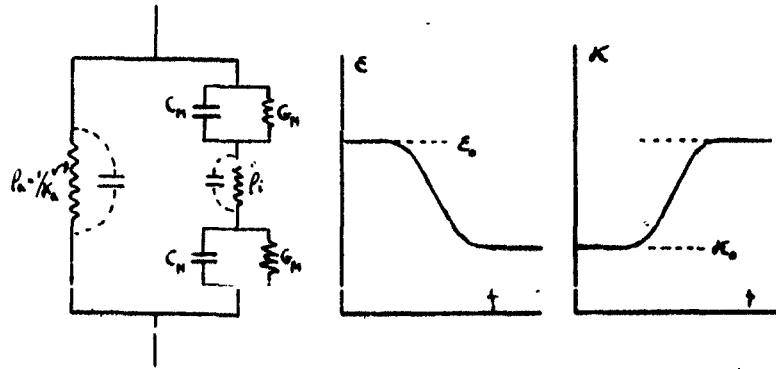

$$\epsilon_0 = \frac{9}{4\epsilon_r} \frac{PRG_M}{[1 + RG_M(\rho_i + \frac{1}{2}A)]^2} \sim \frac{9}{4\epsilon_r} PRC_M$$

$$\kappa_0 = \kappa_a \left[ 1 - \frac{3}{2}p \frac{1 + RG_M(\rho_i - R)}{1 + RG_M(\rho_i + \frac{1}{2}A)} \right] \sim \kappa_a (1 - 1.5p) + \frac{3}{4}pRG_M$$

Fig. 3. Equivalent electrical circuit of tissue (simplified form) and cell suspensions. The circuit indicates how the presence of cell membranes of high capacitance can give rise to the observed dispersion effects. Formulas denote limiting capacitance and conductance at low frequencies as function of the structural parameters  $p$  (volume concentration of cells),  $R$  radius of cells, and  $C_m$  and  $G_m$  (capacitance and conductance per unit area membrane surface). The specific resistances  $\rho_i$  and  $\rho_e$  pertain to internal and external cellular phase. The formulas apply for spherical cells. Somewhat more complex formulas have been given for ellipsoids.

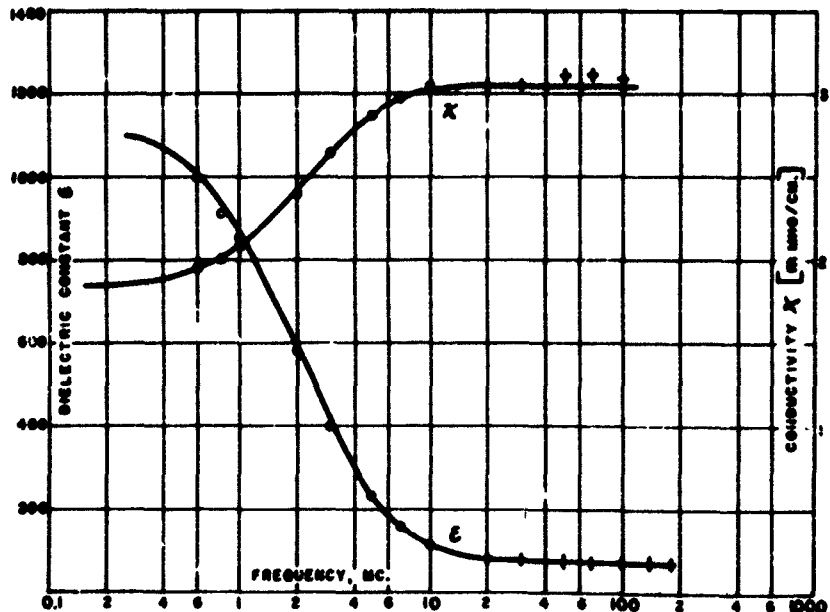

Fig. 4. Dielectric properties of a suspension of spherical (lysed) erythrocytes are compared with the theoretical curves. From such data it is possible to determine structural parameters characteristic of the cells, utilizing formulas given in part in Figure 3.

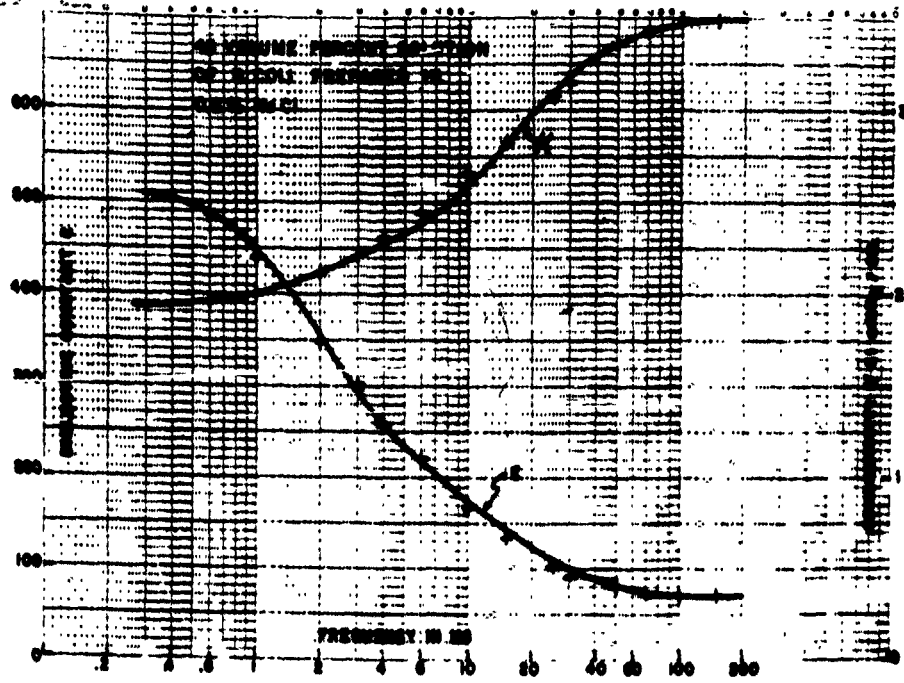

Fig. 5. Dielectric properties of a suspension of B. Coli are chosen to demonstrate the variety of cells, tissues and bacteria which display dispersion phenomena in the rf-range.

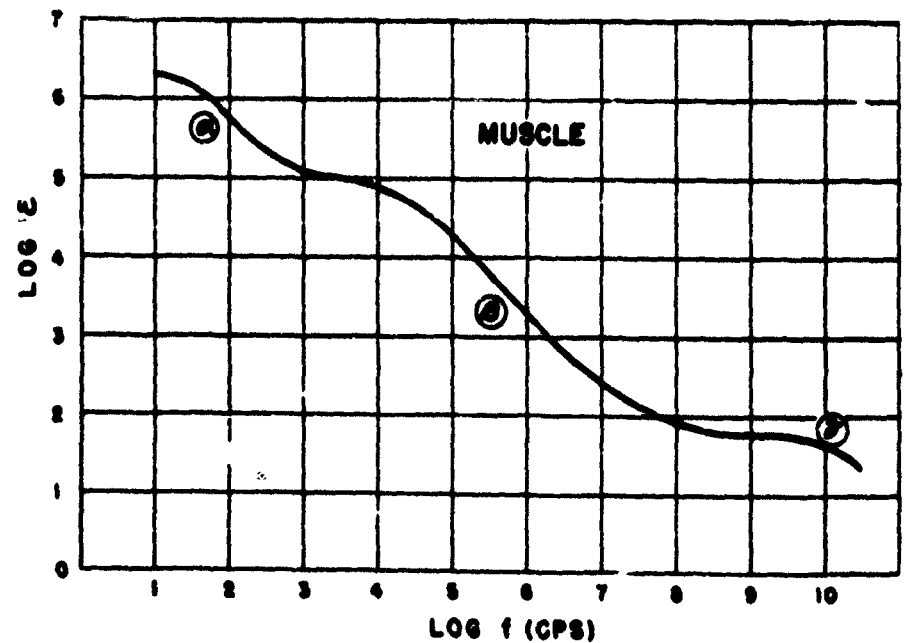
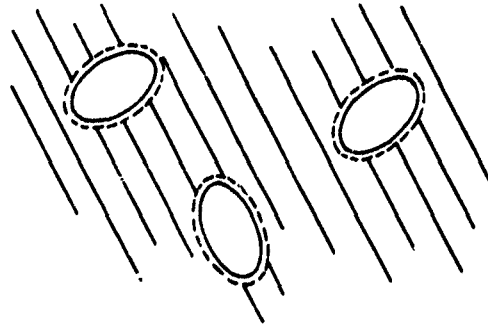

Fig. 6. Dielectric constant of muscular tissue as function of frequency. The complete frequency plot from 10 cps to 30,000 mc shows the existence of three dispersions ( $\alpha$ ,  $\beta$ ,  $\gamma$ ). The  $\beta$ -dispersion is "structural" in origin and of the origin explained before, the  $\alpha$ -dispersion, too low frequency to be of interest for the radar range of frequencies. The  $\gamma$ -dispersion, in the radar range, is in part due to the polar characteristics of water and in part reflects the existence and properties of biological macromolecules.

The model in Figure 7 depicts a suspension of practically loss free particles in a conducting solution. These loss free particles might be solid constituents (e.g., Hb molecules inside erythrocytes or proteins and nuclear proteins in cells) surrounded by electrolytes. Then by simple theory both the resistivity and the dielectric constant of such a solution can be explained to a first order approximation in terms of a certain parameter ( $m$ ) which is between 1.5 and 2, depending upon the shape of the particle and the concentration ( $p$ ) of such particles. Thus, a major discrepancy between the dielectric properties of tissue electrolytes and tissue itself, as observed in the radar range, is explained by this "dielectric hole" approach. However, the finer details of experimentally observed data shall require further comment.

Consider the actual dielectric properties for a 10 per cent hemoglobin solution as plotted in a frequency range of 1 megacycle to about 1,000 megacycles (Figure 8). Observe a strong fall-off in the 1 to 10 megacycle range. This is essentially the end of an S-curve centered near one megacycle range and due to polarity of Hb. The curve should become constant as indicated by the dashed line, but a rho phenomenon occurs, prohibiting the saturation to a constant level. The solid line indicates a further constant rate of fall of the dielectric constant as the frequency increases further. Very exacting measurements are difficult to obtain, but there is no doubt about the constant fall-off indicated by the points of measurement closely surrounding the solid line.



$$\frac{\epsilon(\text{soiv.})}{\epsilon} \sim 1 - mp \quad ; \quad \frac{\epsilon}{\epsilon(\text{soiv.})} \sim 1 - mp$$

$$P = [1 + P_s] \times G \times d \sim G$$

$$\sim 0.3 \frac{g(P)}{100 \text{ CC}} \sim 0.75$$

$$1.5 < m < 2$$

Fig. 7. A solution of nonconducting particles of very low dielectric constant in a solvent of properties  $\epsilon(\text{soiv.})$  and  $\epsilon$  illustrates why the "plateau" between  $\gamma$ - and  $\beta$ -dispersion deviates from the electrical properties of tissue electrolytes. ( $p$  volume concentration of particles,  $m$  form factors which varies with the size of the particles between 1.5 and 2.) The volume percentage taken by hydrated proteins is nearly identical with their weight percentage  $G$ , if hydration  $P_s$  is assumed reasonable (about 0.3) and a density of the protein of about  $d=0.75$  introduced.

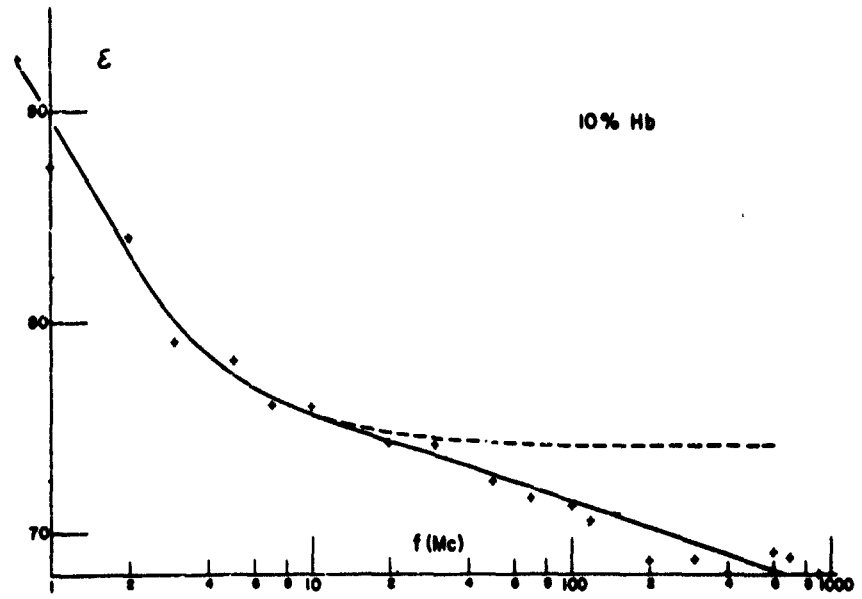

Fig. 8. Frequency dependence of the dielectric constant of a 10% Hb solution in water. The dashed curve indicates the behavior to be expected if the protein matter would not display ultra-high frequency dispersion effects.

The so-called dielectric increment calculated from the data in Figure 8, which is the change in the dielectric constant resulting from the introduction of 1 gram of protein material in 100 cc solution, is plotted in Figure 9. According to our simple "dielectric hole" theory, it should remain constant and be about 1.2, but with increasing frequency it reaches this value rather slowly, with pronounced deviations at frequencies below 300 mc.

In Figure 10 the conductance of a protein solution (Hb) is plotted as a function of frequency between 100 and 1,000 megacycles. Protein particle conductance levels are very small in comparison to those of biological electrolytes. But the protein material in itself shows a definite frequency dependence. This has nothing to do with the electrolytes around the Hb-molecules since in this case a correction has been made for the electrolyte frequency dependence. Let us now interpret the findings presented in Figures 9 and 10.

Protein molecules are known to be surrounded by a particular type of water, 'bound water,' which is differentiated from 'free water,' i.e., they are hydrated. We interpret the dielectric data for proteins in terms of effective dielectric constants of the hydrated protein molecule. It becomes apparent in the necessary calculations that an assumption is then necessary regarding the amount of bound water per molecule. The graph (Figure 11) shows two curves depicting the effective dielectric constants of the hydrated Hb-molecule when two values of bound water are assumed. If the hydrated protein molecule were completely inert, then its dielectric constant would be low, probably between 2 and at the



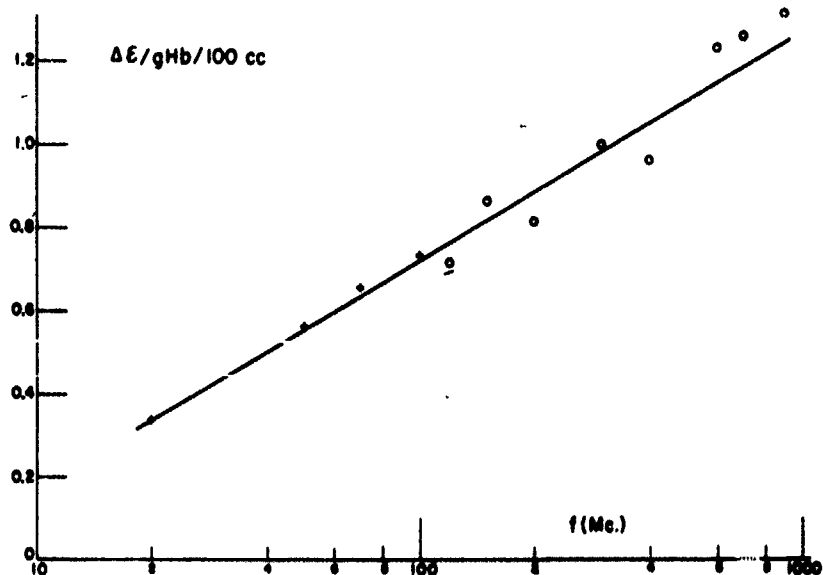

Fig. 9. Dielectric decrement of Hb as function of frequency. The theoretical value which can be predicted from the model in Figure 7 is approached at first at 100 mc (1.2).

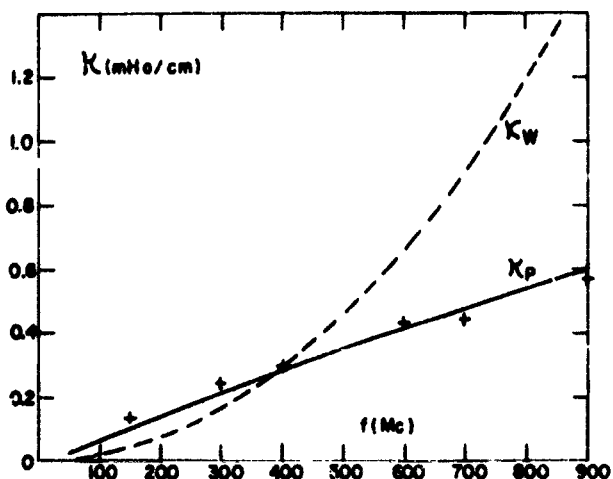
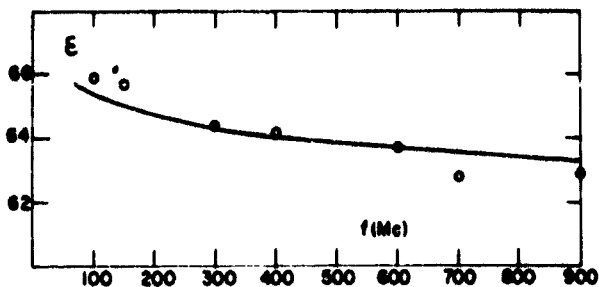

Fig. 10. Dielectric dispersion is accompanied by dispersion of conductance in Hb-solution. The dispersion in the protein conductance  $K_p$  added to the dispersion of water (dashed line  $K_w$ ), gives the total experimentally observed frequency dependence.

most 5. These values obviously are approached at frequencies in the neighborhood of and above 1,000 megacycles. At lower frequencies, however, the values are higher than 20. This must mean that electrical polarization within the hydrated protein is quite substantial. There are two possible explanations for this, and one is illustrated in Figure 12.

It is possible that the dielectric properties of the 'bound' water surrounding protein molecules are a function of frequency (Figure 12). 'Free water' has been quite thoroughly investigated and found to undergo dispersion at 20 kilomegacycles. Ice is known to conform to a similar dispersion curve at rather low frequencies (audio frequency range). Putting the blame for the dielectric properties of proteins on the bound water, it is possible to conclude that the bound water has its dispersion curve near 300 mc; i.e., between ice and free water. This is a possible hypothesis to explain above discussed results.

A better way to explain these same results is on the basis of polar properties of the Hb-molecule. The protein molecule is composed of a number of parts, each of which can be assumed to be electrically polar in nature. If polar side groups are assumed to have a sufficient degree of freedom to partially rotate in an electrical field, then the frequency dependence becomes immediately reasonable. Consider a tree, which is analagous to the total protein molecule. Its branches are the side chain groups. The tree remains stationary while the branches are moved by the wind, unless the frequency of movement is such to move the tree as a whole.

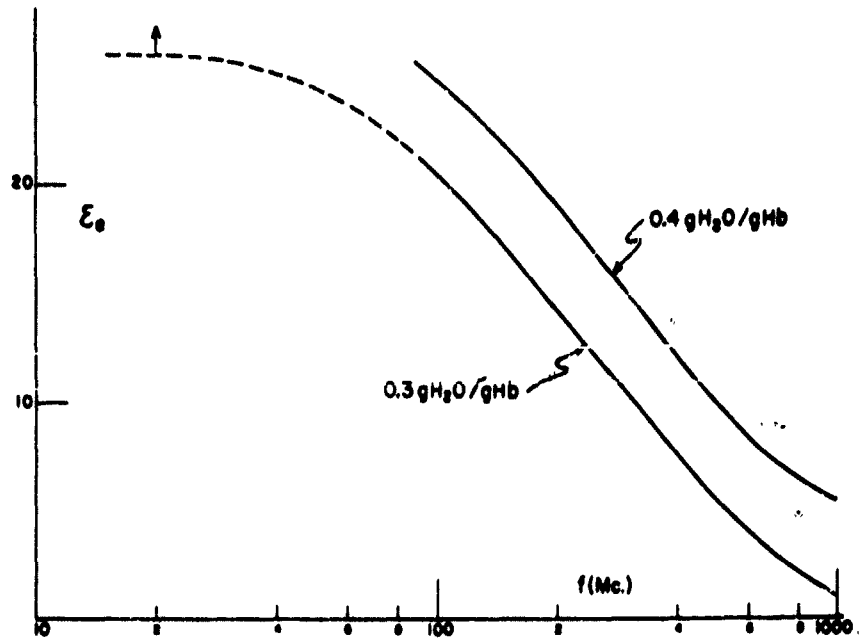

Fig. 11. Effective dielectric constant of hydrated Hb-molecule as function of frequency. The curves have been calculated here for two assumed hydration values (0.3 and 0.4). The graph demonstrates the very pronounced dispersion of the protein matter in itself.

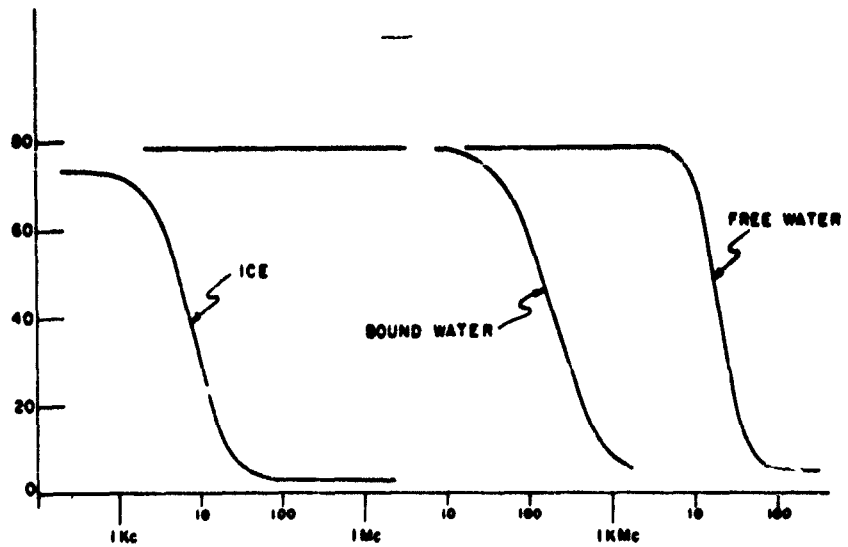

Fig. 12. Frequency dependence of the dielectric constant of ice, bound and free water. The curve for bound water follows if it is assumed that the dispersion of the effective dielectric constant of the Hb-molecule is caused by its hydration.

Increasing the wind velocity will cause greater movement of the branches. Similarly, by increasing the field strengths, movement of the side chain groups will increase in amplitude accordingly. When the alternating field strength becomes very high, the side groups are oriented completely. At this point the phenomenon known as dielectric saturation takes place. This term means that the dielectric constant as measured at a low field strength is constant at first, but starts to fall off as higher field strength values are approached. This phenomenon normally occurs in small molecules at tremendous field strengths at first. For example, the dielectric constant of the water molecule falls off by one per cent at a field strength of about 200 kilovolts per centimeter. The theory of dielectric saturation is not very complete, but it is normally conceded that the saturation is proportionate to the fourth power of the dipole moment. The dipole moment which is ascribed to the charged side groups may be at least one hundred times greater than the dipole moment of the water molecule. In effect, this means that complete orientation can take place at field strength values corresponding to average power levels or, more likely, higher power levels during the pulse of present radar equipment. At the moment when complete orientation takes place, the chance of bond breakage becomes likely. Again, an analogy would be turning the branch on the tree in the direction of the wind and then pulling until it comes off. Dielectric saturation is a prerequisite for denaturation, and this is the first mechanism I am bringing to your attention as a possible nonthermal one. As obvious from above and in summary: denaturation from high field strengths

is most likely to occur at frequencies in the 100 to 300 megacycle range and gradually decreases as the frequency increases above 1,000 megacycles.

Another possibility for nonthermal effects is based on a phenomenon known as 'pearl chain formation.' This is best exemplified by the alignment of erythrocytes in a chain configuration when subjected to a high frequency field. Fat particles are also known to align themselves in this manner. If such a phenomenon could occur at the molecular level, it would appear to have profound biological significance because the natural distribution of certain components would be disturbed.

The formula in Figure 13 represents the ratio of potential energy accompanying alignment to thermal energy; or more graphically,

Figure 13

$$\frac{E(P)}{E(T)} = \frac{1.4 \xi a^3 E^2}{kT}$$

Where:  $\xi$  is the dielectric constant  
 $a$  is the radius of the particle under consideration  
 $E$  is the field strength  
 $k$  is the Boltzmann constant  
 $T$  is the absolute temperature in Kelvin

$E(P)$  is the potential energy associated with the alignment of two particles

$E(T)$  is the thermal energy

ASSUMPTIONS:

a) Particle -  $\xi \sim 1$   
 Solve -  $\xi \sim 80$

b) Room temperature,  $T \sim 300$

$E(P) = E(T)$  if for

1) Blood ( $a \sim 3\mu$ )

$$E = 2V/cm \quad W = 30mW/cm^2$$

2) Subcell. comp. ( $a \sim 1\mu$ )  
 (mitoch., nucl., etc)

$$E = 10V/cm \quad W = 800mW/cm^2$$

3) Protein ( $a \sim 0.01\mu$ )

$$E = 10^4V/cm \quad W = 800KW/cm^2$$

it represents the likelihood of two particles aligning themselves in the direction of the field and becoming part of the chain. When the value of  $\frac{E(P)}{E(T)}$  is equal to or greater than one, chain formation is more likely to take place. If it is smaller than one, if the thermal energy is too great, alignment of the particles will be hindered.

Upon applying data to the equation in Figure 13, chain formation of red blood corpuscles and particles of a similar size is seen to appear probable. Perhaps even subcellular components would behave in this manner, but it is improbable that this phenomenon would occur in proteins or other particles of a corresponding size.

#### Summary

It is possible to conclude from available information that (a) effects of orientation may definitely exist at levels of organization down to about one micron, and (b) that breakage of molecular bonds may occur under pulsed conditions involving high field values and at the lower end of the radar frequency range.

## NEW CONCEPTS IN PERSONNEL PROTECTION

by

George M Knauf, Colonel, USAF (MC)  
Rome Air Development Center

I asked for this short space in the program in order to introduce what I believe is a new concept in our approach to the radar hazards problem.

I wanted to have these few comments set apart from any other piece of the program so that I might have some chance of discussing this area without having what I say used in relation to some existing equipment.

I have explained that in my position I am forced to think in terms of the equipment in use today and also to trace the steps necessary in relation to equipment to come. I speak now exclusively of equipment to come.

It would appear that we have not far ahead of us equipment that will introduce a new set of problems. The specific characteristics of this gear are classified and cannot be discussed here. However, the factors with which we are concerned are not of a classified nature. We will soon be operating radar sets, the configuration of which will be such as to require personnel to work for varying periods of time in an environment which will reach our maximum safe exposure level. On certain occasions in connection with various work tasks personnel may be required to enter areas where the ambient power level will exceed our safe exposure level. The magnitude of these equipment arrays is such as to involve exposures

of considerable time duration by personnel moving between their living quarters and their work stations. These considerations make the provision of protective clothing seem inevitable. Such clothing must be so designed as to permit the wearer to do his required work while wearing it.

In an attempt to exploit the possibility of devising protective clothing for personnel working in high R-F fields, a preliminary investigation has been conducted at RADC. The basic intent of the investigation was to determine the availability of materials which display the proper electrical and structural characteristics. To this end, several fabric manufacturers were solicited in an attempt to secure samples which could be submitted to electrical tests. The fabrics that have been received to date have been tested over the frequency range of 200 to 600 megacycles to determine the approximate transmissibility through the fabric. One enterprising manufacturer had the foresight to submit his sample in the form of a fabricated suit. This is the proprietary item that we have displayed here. (Figure 1).

The electrical tests performed on these materials were performed by measuring the free intensity with a calibrated dipole and then recording the reading when the fabric was inserted between the source and the dipole. The difference in readings under these conditions was considered the transmission loss. In testing the garment essentially the same technique was used with a few minor additions. The dipole was inserted through one of the leg openings and positioned at approximately chest level. All of the openings, arms,



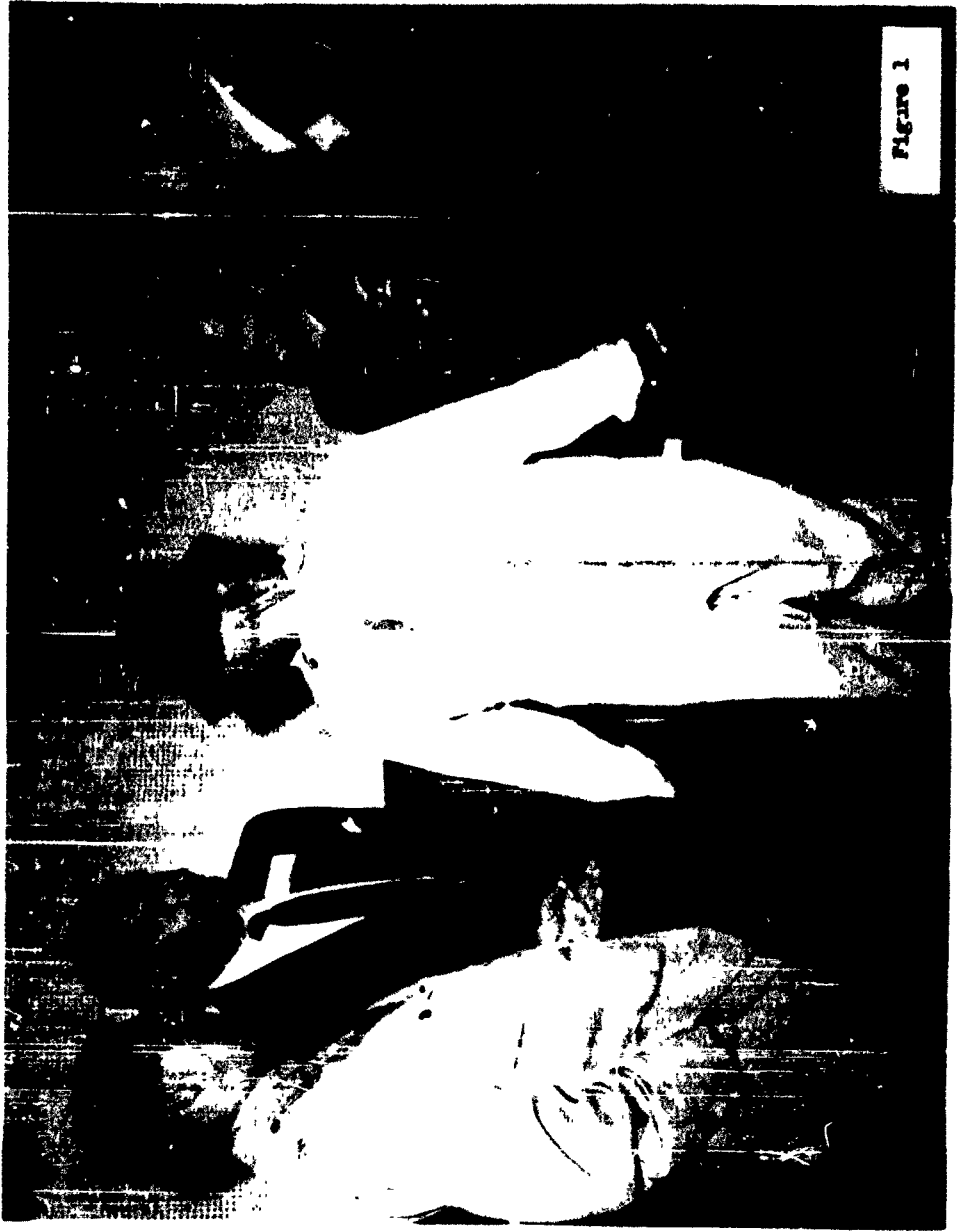

Figure 1

legs, and neck were then sealed with absorbent material. The measurements obtained at the dipole with the suit in various rotational positions were then compared against the dipole measurement in the free field. Needless to say wide differences were encountered between different materials. Some materials displayed a transmission loss in the order of 100 to 1 across the frequency band tested while others were of the order of 1 or 2 DB transmission loss. Tests on the suit in its present form indicate that the transmission loss is greater than 10 DB or 10 to 1 power loss. Although little effort was expended in devising a rigorous measurement technique, it should be noted that the above tests were predicated on good engineering principles. Well matched components were employed in a microwave free space room. The measurements performed could be in error by at least 3 DB. However, the above data is corrected for the most pessimistic error.

Based on this very limited investigation, it appears that reflective fabrics presently available possess to some degree the electrical and structural characteristics necessary for the fabrication of a microwave radiation suit. It has also been demonstrated that the fabric could be assembled into an item of clothing that is reasonably light weight and durable in structure. It is fully realized that the program discussed here is extremely limited and subject to considerable argument. However, it is felt that the above study establishes in part the feasibility of developing a microwave radiation suit which will allow personnel to work in microwave fields in excess of the present .01 watts/cm<sup>2</sup> threshold.

In an attempt to add continuity to the above investigation, RADC personnel have thrown together a head shield which possesses essentially the same electrical characteristics as stated above and demonstrates the feasibility of R-F shielding without appreciable optical obstruction.

The other new approach involving safety in traveling to and from work areas would appear to be best approached by providing shielded passageways through all of the potentially hazardous areas. At the moment it would seem that these passageways would be of considerable size and length. I feel it is essential that you know that we approach a point where we will not be able to solve our problem by posting the area with hazard signs.

Again let me remind you that this all refers to equipment to come.

## THE PATHOLOGY OF HYPERPYREXIA

by

Frank W. Hartman, M.D.  
Office of the Surgeon General, USAF

### COLONEL KNAUF:

Throughout all of our discussions of the effects of microwaves on body tissues, we face the problem of accurately assaying the part a thermal change might play in accounting for such changes as might be observed.

It seems appropriate that we pause and review the general effects of hyperpyrexia on selected living tissues. I believe this procedure might serve to assist us in determining just what paths our research effort should follow and to assist us in evaluating the findings that may result from this effort.

To this end we have been indeed fortunate in persuading Dr. Frank Hartman, the Medical Research Advisor to the Surgeon General of the Air Force to talk to us on this subject.

Dr. Hartman is a nationally recognized pathologist, an outstanding authority on this subject and a man who has from its beginning displayed a keen interest in and understanding of the many knotty problems involved here.

I am sure we will all profit from the guidance he will give us today.

### DR. HARTMAN:

In the first conference on the Biological Effects of Microwave Energy, Colonel Knauf spoke on the rapid development in the field of electronics as it involves communications, navigation and detection. Further, it was pointed out that radar sets in the foreseeable future may produce peak power outputs as high as 100 megawatts, producing new frontiers of biological effects demanding intensive research.

The acute biological effect of microwaves has been established by experiments on various species of animals by Boysen<sup>1</sup>, Brody<sup>2</sup>, Clark<sup>3</sup>, Cook<sup>4</sup>, Dally and associates<sup>5</sup>, Davis and Mayer<sup>6</sup>, Ely<sup>7</sup>, Engle<sup>8</sup>, Follis<sup>9</sup>, Herrick, Hines, Krusen and Osborne<sup>10</sup>, Richardson<sup>11</sup>, Schwan<sup>12</sup>, Wakim<sup>13</sup>, Williams<sup>14</sup>, Carpenter<sup>15</sup>, and others. It is generally agreed that these acute effects are due largely to local or general hyperthermia in the body tissues. Relatively short exposures to peak power output of the recently developed installations will be capable of producing hyperpyrexia up to or beyond the limits of tolerance.

Much additional research must be accomplished employing the available higher power output. These are now under investigation with the more recently negotiated contracts, but some measure of man's tolerance to hyperpyrexia may be obtained from the existing literature which antedates the work on radar proper by 10 to 15 years.

The physiological and pathological reactions to hyperpyrexia alone induced by whatever mechanisms, such as hot baths, heated cabinets, diathermy, heat stroke, thermal burns and microwaves, are essentially comparable and have been well studied and recorded by Neymann<sup>16</sup> and Osborne, 1934, Bierman<sup>17</sup>, 1934, Hench, Slocumb and Popp<sup>18</sup>, 1935, Hartman<sup>19</sup>, 1935 and 1937<sup>20</sup>, Haymaker<sup>21</sup>, 1946, and Gore<sup>22</sup>, 1949.

Injury from exposure to heat is by no means a recent discovery. William H. Welch<sup>23</sup> gave lectures "On the General Pathology of

Fever" in 1888, warning against transferring the results of experiments in heat dyspnea, observed in animals, directly to man because in animals respiration has a far more important influence on temperature regulation than in man --- a dog pants, a human sweats....

Osler<sup>24</sup> gives to heat stroke the distinction of being the oldest known disease, although its nature was long obscured by superstition.

The earlier experimental work on and the pathology of, heat stroke is typified by the report of Hall and Wakefield<sup>25</sup> (1927). Dogs were placed within a heated humidified chamber with dry bulb temperatures ranging from 131°F. to 141°F. and wet bulb from 95°F. to 115°F. for 20 to 75 minutes. Rectal temperatures of these animals reached 106°F. to 113.4°F. Gross pathology produced included congestion of organs and tissues, except the intestine which was rigidly contracted, microscopically--cellular degeneration of varying degrees was found consistently but was most prominent in the liver, kidneys, intestines, brain, lungs and thyroid.

Baldwin and Nelson<sup>26</sup>, 1928, described the pathology produced by high frequency currents in rats exposed 4 to 30 minutes and resulting in rectal temperatures as high as 113°F. Their findings were: early cellular coagulation and degeneration in the heart, liver and kidneys, with congestion and blood extravasation. Necrosis and exfoliation of the cells of the intestinal mucosa was noted, but this healed rapidly.

In 1931, Jacobsen and Hosoi<sup>27</sup> produced elevated temperatures

of 107° F. to 112.4°F. in dogs with "radiothermy" over periods of 37 minutes to 30 hours. Most of the animals succumbed to this treatment, but five were sacrificed from one hour to eight days following the exposure. The pathology recorded consisted of congestion, dehydration, petechial hemorrhages, especially in the gastro-intestinal tract, and cellular degeneration, including that of the seminiferous tubules.

Our own experience reported in 1935<sup>19</sup> consisted of observations made on dogs and patients given hyperthermia with the standard Kettering Hypertherm for the latter and modified for the dog experiments. The cabinet was conditioned with circulating hot air and steam giving temperatures from 150° F. to 175°F. and humidities of 30 to 40 per cent.

The animals were sedated with morphine and/or sodium amytal and bandaged with multiple layers of cotton blanket strips to prevent discomfort and injury to the skin. Fluids by mouth were given.

Thirteen dogs received a single exposure while five were given two exposures with intervals of 24, 48 or 72 hours between. Time of exposure ranged from 5 to 7 hours. The maximum temperatures attained varied from 106.2° to 110.4° F.

The gross pathology consisted of marked congestion and engorgement of tissues and organs with hemorrhage beneath the rectus sheath in one instance. The lungs showed discrete and confluent areas of hemorrhagic consolidation. The brain showed marked oedema, engorgement of blood vessels and perivascular hemorrhages throughout the basal nuclei. Microscopic lesions were general oedema and engorgement of blood vessels, lung consolidation due to filling the alveoli by R.B.C. and leucocytes, mid-zonal necrosis of the liver

associated with hemorrhage in some instances, swelling and desquamation of the lining of the small intestine, vacuolar degeneration of the adrenal cortex, vacuolar and granular degeneration of the tubular epithelium of the kidney, and engorgement with blood in the capsular spaces.

#### HUMAN CASES

Case No. 1: White female, age 20, with clinical diagnosis of acute salpingo-oöphoritis complicating 3 months pregnancy. Given three treatments of five hours each in the Kettering Hypertherm with seven day intervals between. Sodium amytal was used as a sedative and maximum temperatures ranging from 103° to 106°F. were reached. The treatments appeared to be well tolerated and the mass in the adrenexa cleared, but 48 hours after the completion of the last hyperthermia the patient became irritable and had a minor convulsion described as a twitching spell. A similar generalized tremor was noted on the seventh day, and a frank convulsion lasting nine hours with coma and death on the tenth day. The only marked gross pathology consisted of petechial hemorrhages in the basal nuclei of the brain. Microscopically there were small areas of hemorrhagic pneumonia, granular and vascular degeneration of the adrenal cortices, parenchymatous degeneration in liver and kidneys, devastation necrosis and cuff hemorrhages throughout the basal nuclei of the brain.

Case No. 2: Male, age 40, with history of central nervous system syphilis for six months and treated showed improvement. Was given a series of treatments comparable to that outlined in the first patient. After the last treatment, he became comatose



and died 20 hours later.

The positive gross necropsy findings were luetic aortitis, hemorrhagic pneumonia, bilateral, parenchymatous degeneration of liver and kidneys with engorgement and congestion, and hemorrhages throughout the basal nuclei of the brain. Microscopically the hemorrhagic pneumonia and the oedema and petechial hemorrhages in the brain were most striking.

Case No. 3: White male, age 31. Diagnosis: bilateral iridocyclitis of two years duration. Was treated with a series of six hypertherm exposures under sodium amytal in five--the last under paraldehyde. Intervals of four to seven days were maintained between treatments and the eyesight improved. After six months a second series of treatments were given, but twenty hours after treatment his limbs became flaccid, the right side of the face weak, and he died in coma.

Postmortem gross findings were: congestion and oedema lower lobe of lungs, petechial hemorrhages throughout epicardium; congestion of liver, spleen and kidneys; cerebral vessels intact, marked oedema of brain, right cerebellar lobe hemorrhagic and necrotic. Microscopically, aside from oedema and congestion, the principal lesions were in the cerebellum with the left lobe showing oedema and areas of hemorrhage, the cerebellum showed disintegration of the Purkinje cells, and the right lobe showing extensive necrosis and hemorrhage. The cerebrum showed the pyramidal cells poorly staining and surrounded by large clear spaces as were the smaller blood vessels.

The clue to the pathogenesis of the lesions produced in the animals and the three human cases described by exposure to carefully

controlled hyperthermia appeared in the parallelism between these and the lesions of hypoxia. The relatively heavy sedation required (morphine, sodium amytal and paraldehyde) plus the extended and the repeated period of hyperpyrexia with each degree of temperature increasing the metabolic rate 5 to 14, or an increase of 37 to 100 per cent, at 106°F., are recognized etiological factors in anoxia. Actual examinations of the arterial blood in a typical experiment after 5 hours and 15 minutes at temperatures averaging 106°F. showed the oxygen content 15.59 volumes per cent, oxygen capacity 26.65 volumes per cent, and oxygen saturation 59 per cent. The venous blood showed the oxygen content 11 volumes per cent and the oxygen saturation 41 per cent.

In a series of 14 dogs, the oxygen saturation of the arterial blood was reduced an average of 16 per cent during exposure to hyperthermia, with a maximum reduction of 26 per cent. In addition there is the factor of histotoxic anoxia from the sedation which prevents the cellular utilization of the available oxygen.

Another bit of indirect evidence supporting anoxemia as the principal etiological factor in the pathology of hyperpyrexia is the fact that the continuous administration of oxygen to the experimental animals and to man maintained the oxygen saturation at normal levels and prevented the lethal effects.

The report of Gore and Isaacson<sup>22</sup>, 1949, giving the pathology observed in 17 autopsied cases of hyperpyrexia resulting from fever therapy, 14 with the Kettering Hypertherm, emphasizes lesions in the liver-centrolobular necrosis, in the C.N.S.-focal neuronal degeneration, especially the Purkinje cells, and congestion with petechiae and ring hemorrhages. In the kidneys there was tubular degeneration

with pigment casts; in the heart there were focal degenerative changes and fragmentation of the myocardium; in the lungs hemorrhagic pneumonia; in the adrenals disintegration of the cells in the fasciculate zone; in the testes spermatogenesis markedly decreased with multinucleated cells forming in the walls of the tubules; and in the gastro-intestinal tract oedema and congestion.

Dr. Gore subscribes to our conclusions that anoxia constitutes the prime injurious factor in hyperpyrexia, and that the identical lesions seen in anoxic and hyperpyrexia are produced by the same mechanism.

The more recent observations on hyperpyrexia are those of Malamud, Haymaker and Custer<sup>21</sup>, 1946, recorded in a paper entitled "Heat Stroke--A Clinico-Pathological Study of 125 Fatal Cases", and summarized as follows: A defect in blood coagulation due principally to thrombocytopenia since counts on admission ranged from 22,300 to 120,000 and from 40,000 at the sixth hour to 90,000 on the third day.

The most conspicuous pathological lesions were found in the C.N.S., progressive degeneration of neurons, congestion, oedema and petechial hemorrhages, changes in the viscera were hemorrhagic and parenchymal; degeneration of megakaryocytes, necrosis of heart muscle, lobular pneumonia, lower nephron nephrosis, centrolobular necrosis of the liver and degeneration of the adrenal cortex. The thermostatic function of the hypothalamus is impaired by the increased body temperature resulting in the autonomic nervous system's no longer capable of establishing sweating and adequate peripheral circulation.

Daily, Zeller, Benedict, Wakim and Herrick<sup>28</sup>, 1951, found

that exposure of the rabbit eye to a microwave generator with output of 94 watts for ten minutes at two inches produced reduction in the activity in the pyrophosphatase of the lens comparable to the visible damage. Neither pyrophosphatase or peptidases were reduced when no severe injury was visible. Almost complete loss of activity of adenosine triphosphatase and pyrophosphatase in total cataracts.

Gore suggests that enzymes are characteristically sensitive to alterations in temperature and that with prolonged fever they may be affected to change their functional activity. If cellular metabolism stops, necrosis may result, or if metabolism is decreased, dysfunction occurs as may be manifest by reduction of prothrombin and fibrinogen in the liver.

#### DISCUSSION AND CONCLUSIONS

A review of the pathology of hyperpyrexia from exposures to heat producing mechanisms and environments, including microwave radiation, is presented not with the assumption that the entire biological effect of microwave radiation is due to heat, but with the conviction that most, if not all, of the acute deleterious and disastrous effects may be properly ascribed to heat in view of existing data.

The careful analytical report of Haymaker and his associates on 125 cases of "Heat Stroke" collected during World War II details all the lesions resulting from this type of exposure. Although the findings are comparable in most respects, the lesions resulting from heat exposure such as in fever therapy where the variables of temperature, humidity and time are controlled and the condition of the patient prior to exposure are recorded offers the best controls for the study of lesions produced experimentally or accidentally by

microwaves.

Ely<sup>7</sup> has stated the problem briefly as follows: "The lens and testes owe their special sensitivity to (microwave radiation) their physical location relative to the body surface, their poor ability to dissipate heat, and in the case of the testes, high sensitivity to temperature increase. The body as a whole can tolerate only moderate temperature increase, and has a limited ability to lose heat."

The limited ability to lose heat is compounded by the fact that for every degree of temperature above normal there is a 5 to 14 per cent increase in the basal metabolic rate requiring from 50 to 100 per cent increase in the supply of oxygen to the tissues. The situation is further complicated by reduced oxygen combining capacity of the hemoglobin, increased rate of blood flow, reducing time available for oxygen transfer, and fever hyperpnea resulting in an alkalosis increasing the stability of the hemoglobin with interference of oxygen release to the tissues. The combination of these factors results in the severe anoxia demonstrated in our series of fever therapy experiments.

The hazard of acute localized hyperthermia produced by microwaves is well established for the eye and the testes. This hazard is much less in other organs and tissues of the whole body because of more ample heat dissipating factors, but with increasing power outputs even these safety factors might be inadequate and any or all of the lesions described in connection with hyperpyrexia could result. Such a possibility may become a reality if an individual in the performance of his duty should come near the limit of his heat tolerance, and then have exposure to microwave heat with that

tolerance being rapidly destroyed. Again, a longer exposure to microwave heat alone could produce an irreversible hyperpyrexia, either local or general, that could produce the lesions described.

## BIBLIOGRAPHY

1. Boysen, J.; Hyperthermic and pathologic effects of electromagnetic radiation; *J. Aviation Med.* 24:516-525, 1953.
2. Brody, S.; The operational hazard of microwave radiations; *J. Aviation Med.* 24:516-626, 1953
3. Clark, J.; Effects of intense microwave radiation on living organisms; *Proc. IRE.* 38:1028-1032, 1950
4. Cook, H.; Microwaves in medical and biological research; *British J. App. Phys.* 3:33-40, 1952
5. Daily, L., Wakim, K., Herrick, J., Parkhill, E. and Benedict, W.; The effects of microwave diathermy on the eye: an experimental study; *Am. J. Ophth.* 33:1241-1254, 1950
6. Davis, T. and Mayer, J.; Uses of high frequency electromagnetic waves in the study of thermogenesis; *Am. J. Physiol.* 178:283, 1954
7. Ely, T. and Goldman, D.; Research Report Project NM 001 056. 13.02; Naval Medical Research Institute; 15:77-138, 1957
8. Engle, J. et al; Effects of microwaves on bone and bone marrow and adjacent tissues; *Arch. Phys. Med.* 31:453-461 1950
9. Follis, R. Jr.; Studies on the biological effects of high frequency radio waves (radar); *Am. J. Physiol.* 147; 281-283 1944.
10. Osborne, S. and Frederick, J.; Heating of human and animal tissues by means of high frequency current of 12 cms wavelength (microtherm); *Quart. Bull. Northwestern Univ. Med. School* 23:222-228, 1949
11. Richardson, A., Duane, T. and Hines, H.; Experimental cataract produced by 3cm pulsed microwave irradiations; *Arch. Ophthl.* 45:352-356, 1951
12. Schwan, H. and Piersol, G.; The absorption of electromagnetic energy in body tissues, Part I; *Am. J. Phys. Med.* 33: 371-404, 1957
13. Wakim, K., Herrick, J., Parkhill, E. and Benedict, W.; Effects of microwave diathermy on the eye; *Am. J. Ophth.* 33:1241-1254, 1950
14. Williams, D., Monahan, J., Nicholson, W. and Aldrich, J.; Biologic effects studies on microwave radiation time and power thresholds for the production of lens opacities by 12.3 cm

- microwaves; IRE Trans. Med. Elect. p. 14-22, 1956
15. Carpenter, R.L.; Informal progress report on the cumulative effects of 12.3 cm. radiation upon the eyes of rabbits; Project 7783-1, AF 41(657)-86, 15 June 1957, Tufts University, Medford, Mass.
  16. Neymann, C.A., and Osborne, S.L.; Physiology of electropyrrexia; Am. J. Syph. and Neurol. 18:28-36, 1934
  17. Bierman, William and Fishberg, E.H.; Some physiologic changes during hyperpyrexia induced by physical means; JAMA; 103: 1354-1357, 1934
  18. Hench, P.S., Slocumb, C.H., and Popp, W.C.; Fever therapy; JAMA; 104:1779-1790, 1935
  19. Hartman, F.W. and Major, R.C.; Pathological changes resulting from accurately controlled artificial fever; Am. J. Clin. Path. 5:393-410, 1935
  20. Hartman, F.W.; Lesions of the brain following fever therapy; JAMA; 109:2116 (Dec) 1937
  21. Haymaker, Webb, Malamud, Nathan and Custer, R.P.; Heat stroke; Military Surgeon, Vol. 99, No. 5, November 1946
  22. Gore, Ira and Isaacson, Norman H.; The pathology of hyperpyrexia; observations at autopsy in 17 cases of fever therapy; Amer. J. Path; 15: 1029-1046, 1949
  23. Welch, William H.; On the general pathology of fever; Med. News, 52:393-405; 1888
  24. Osler, William and McCrae, Thomas; Principles and practice of medicine; ed. 10; New York: D. Appleton & Co., p. 378, 1925
  25. Hall, W.W., and Wakefield, E.G.; A study of experimental heat stroke; JAMA; 89: 177-182, 1927
  26. Baldwin, W.H. and Nelson, W.C.; The histologic effects produced in albino rats by high frequency currents; Proc. Soc. Exper. Biol. and Med. 25:588-590, 1928
  27. Jacobsen, v.C., and Hosoi, K.; Morphological changes in animal tissues due to heating by ultra high frequency oscillator; Arch. Path. 11:744-759, 1931
  28. Daily, L., Zeller, E., Wakim, K., Herrick, J. and Benedict, W.; Influence of microwaves upon certain enzyme systems in the lens; Am. J. Opth. 34:1301-1305, 1951



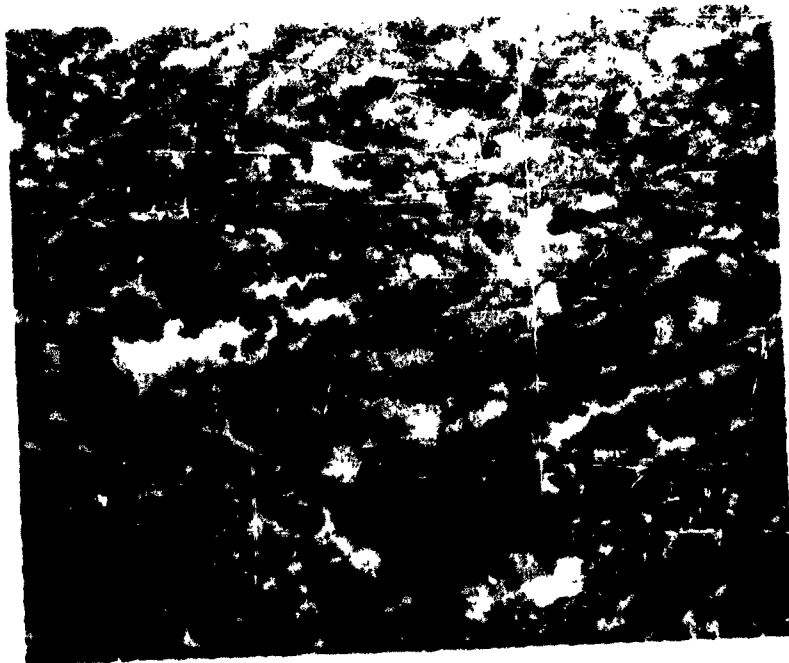

Fig. 1. Showing cuff-like hemorrhage about medium sized vessel in base of brain (medium power).

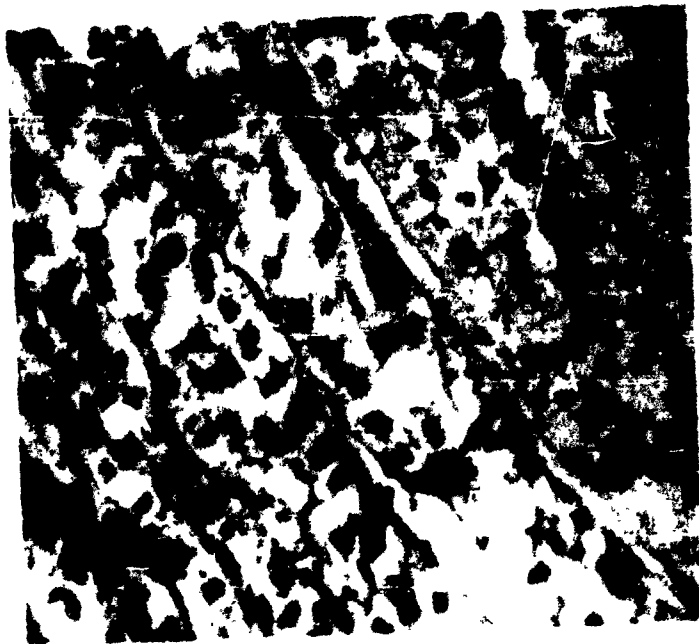
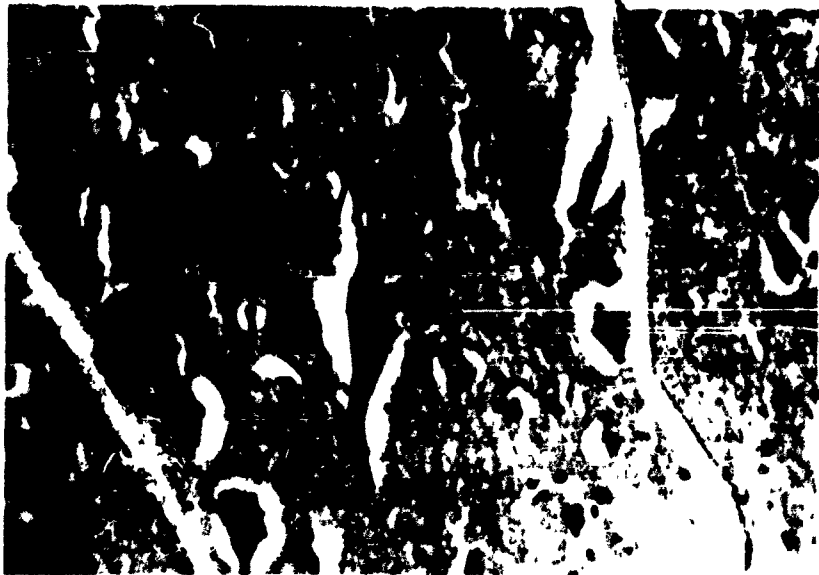
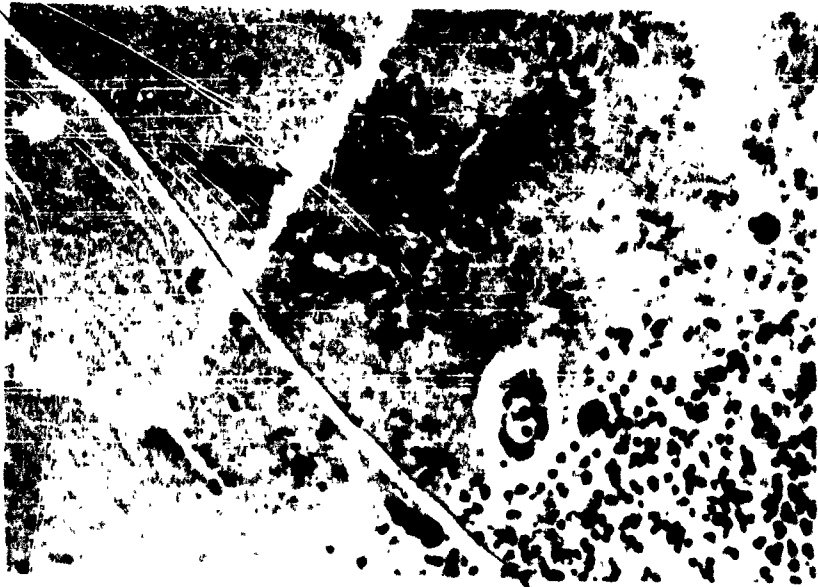

Fig. 2. Showing marked vacuolar degeneration in the zona fasciculata of the adrenal.



Section from the cortex under medium power showing unusually wide paravascular spaces and distorted, shrunken pyknotic pyramidal cells.



Section from the cerebellum under low power showing extensive damage and shrunken, pyknotic Purkinje cells.

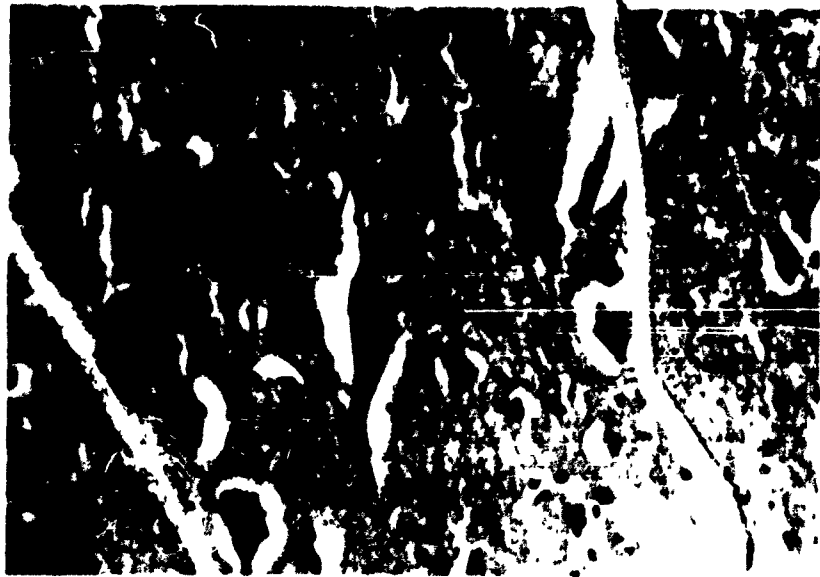

Section from the cortex under medium power showing unusually wide perivascular spaces and distorted, shrunken pyramidal cells.

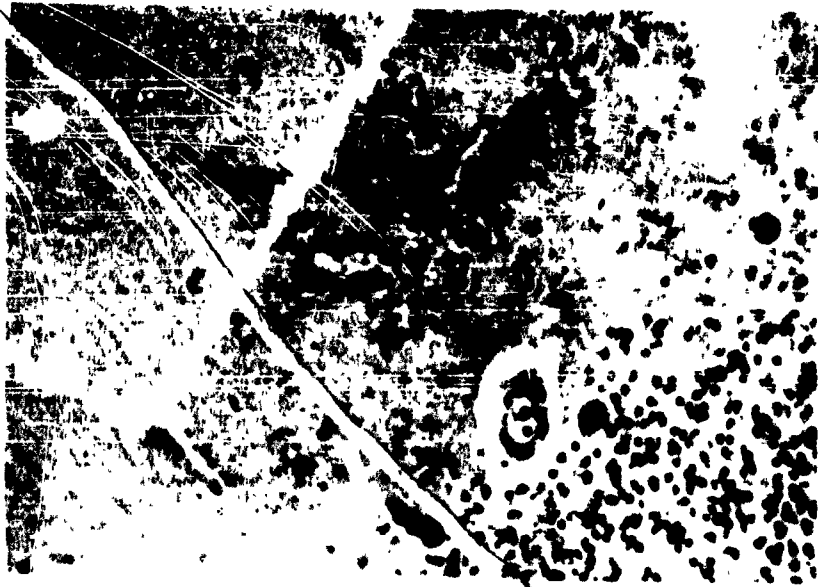

Section from the cerebellum under low power showing extensive damage and shrunken, pyknotic Purkinje cells.

# RADIO FREQUENCY HAZARDS ABOARD NAVAL SHIPS

by

John Roman, Bureau of Ships, USN

## COLONEL KNAUF:

In general, our concern has been with radar of high power located in such a situation as to permit us to dictate separation criteria for adjacent sets and to prescribe the circumstances under which men would approach this equipment. In all cases the problem is not quite as simple as this.

I have in mind the extremely complex situations our friends in the Navy face in coping with safe exposure limits in the case of radar on board ship. I feel that a discussion of this problem is essential if we are to get a complete picture of the over-all radar hazards problem. We are extremely fortunate to have with us today Mr. John Roman of the Bureau of Ships, U. S. Navy, to discuss the problem with us.

## MR. ROMAN:

The limited space and the large number of powerful radio and radar transmitters aboard ship give rise to a number of possible radio-frequency hazards. The purpose of this paper is to generally describe these hazards and to highlight some of the tests and investigations that have been carried out to eliminate or reduce them.

Radio-frequency hazards can be classified into three general categories:

1. Humans
2. Volatile Liquids
3. Electro-Explosive Devices.

A brief description of the type and mechanism of the hazard for each of the categories is as follows.

A hazard to humans can exist whenever metallic objects are handled in the vicinity of high-powered communications transmitters.

An example of this is a plane crew handling aircraft on the deck of a carrier in the vicinity of transmitter whips. Another case occurs with personnel handling loading hooks and cables on cargo ships. The hazard encountered here is burns of the skin occurring when contact is made with the conductor which has induced r-f currents in it. Measurements made from the plane to ground on AD6 aircraft aboard an aircraft carrier showed currents in excess of 1 ampere and voltages up to 300 volts when this aircraft was parked next to a transmitter whip radiating an estimated 1400 watts. In contrast, the perception threshold for an average man has been established at 12 milliamperes at 10kc.

Another type of r-f hazard to humans exists due to microwave radiation from high-powered radars. Research has demonstrated that an exposure of from four to five minutes to a microwave radiation intensity of 0.6 watts/cm<sup>2</sup> can cause damage to human tissues -- particularly the eyes. Another body structure which is susceptible to damage is the testis. It is believed that the 3000 mc. frequency region is the most dangerous because radiant energy of this wavelength can penetrate tissues sufficiently to avoid concentrating heat production in the region of skin receptors, and may produce undesirable temperature elevations below the surface. The Bureau of Medicine has tentatively established a working level of 0.01 watts/cm<sup>2</sup> as the tolerable dosage for constant exposure to microwave radiation.

The volatile liquid hazards exists, to the largest extent, aboard aircraft carriers. Aircraft handlers have noted sparks occurring at various points on the aircraft structure when touched by portions of the body or by metallic objects held in the hand.

These phenomena have caused a great deal of concern as to the possibility of aviation gasoline fumes being ignited by these r-f induced sparks. In order for gasoline to be ignited by a spark, the following conditions must be met:

1. A flammable gasoline-air mixture must exist.
2. The spark must contain a sufficient amount of energy.
3. The gap across which the spark occurs must be a certain minimum distance which is termed the "minimum quenching distance."

Ordinarily, the lower limits of flammability of most gasolines is near 1.25% by volume of gasoline vapor in air; the upper limit is near 7.5%. Mixture near either the upper or lower limits burn so slowly that it is possible to watch the flame travel away from the source of ignition without any evidence of violence.

The extent of the presence of flammable gasoline-air mixtures was investigated by the Naval Research Laboratory in 1948 aboard the USS Coral Sea (CVB - 43). The findings of this survey showed that flammable mixtures are not detected more than 6 inches horizontally or 5 inches vertically from gasoline puddles on the deck at ambient temperatures of 52-64 degrees, Fahrenheit, even in the absence of ventilation. Where there was a guiding surface below the point of release; and no ventilation, flammable vapors traveled greater distances. For example, vapor greater than 125% of the lower flammability limit was pushed out of a filler hole during hanger deck fueling and ran down the fuselage and wing surfaces with only enough dilution to bring it to just 125% at the low point on the trailing edge. However, the vapor became diluted to less than a flammable concentration within 6 inches of free fall, as

7

was typical in all studies of the flow of vapor.

The conclusion of this study was that the handling of aviation gasoline under normal operating conditions, at cool weather temperatures does not produce a flammable atmosphere except close to planes being fueled or close to spilled gasoline. This did not take into account the results of release of large quantities of gasoline through various conceivable accidents or the effects of spilling gasoline on much hotter decks. It was felt that hot weather conditions would greatly extend the hazardous area.

The amount of energy required in an r-f spark to ignite a flammable gasoline-air mixture is unknown. Experiments to date have only been conducted with d-c type sparks. It has been determined that  $3.05 \times 10^{-4}$  watt-seconds of energy is required in a spark of  $10^{-8}$  to  $10^{-6}$  seconds duration across plain electrodes to ignite a propane-air mixture. (Propane has ignition characteristics similar to gasoline.)

The minimum quenching distance for the electrodes used with propane was 1.75mm. The d-c voltage required to break down an air - gap of this distance is approximately 2500 volts. The r-f voltage required to break down a similar gap is unknown, but is believed to be approximately the same as d-c.

Several accidents have occurred during the past few years involving electrically initiated explosive devices which have been attributed to currents induced by radio-frequency fields. These devices may be termed electro-explosive devices because they are designed to function by the passage of an electric current through them. Among such devices are primers, detonators, squibs, gun primers, cannon primers, blasting caps, igniters, initiators, rocket igniters, etc.

The response of an electro-explosive device to an electrical firing signal depends on many factors. Among these are the temperature dependence of the explosive decomposition rate, induction time, activation energy, heat of reaction of the explosive, type and physical characteristics and configuration of the bridge firing pulse power and energy characteristics. The vulnerability of electro-explosive devices to radar and r-f radiation fields also depends on such factors as high frequency reactance, thermal-cooling time constant, pulse repetition rate, and radiated peak and average power.

A large number of tests of a "go", "no go" nature have been performed on electro-explosive devices, but only in few instances have they been set off by radio-frequency fields. In most cases, it has been necessary to idealize conditions artificially in order for an explosion to take place. Although many devices have been tested, the number has been relatively small compared to the variety of such devices in existence. In reality, the total problem has only been superficially examined.

Because of the catastrophic nature of an accidental explosion of some of these devices, a hazardous condition is presumed to exist where they are exposed to high level r-f fields. These assumptions will hold until thorough investigations reveal otherwise.

Due to the possible hazards described above, the Bureau of Ships issued Instruction 96701 in August, 1952 which restricted the use of transmitters of rated power outputs greater than 500 watts during refueling or arming operations aboard aircraft carriers. This Instruction was based on limited data as of that date. Operational experience showed that fleet communications were restricted



as a result of this Instruction. In a naval message to BuShips and BuOrd in 1957, CNO requested that the problem of induced r-f energy be resolved as a matter of priority.

The Bureau of Ships, therefore, sponsored an R-F Hazards Conference on 1 August 1957 to formulate an inter-bureau cooperative effort to provide solutions for the various hazard problems. An agreement was reached at this conference that the first action to be taken would be an electro-magnetic field survey aboard a large carrier. Since the USS Franklin D. Roosevelt (CVA-42) had sent in many reports on potential r-f hazards existing during various types of operations, this ship was selected for the test. The operating schedule of the CVA-42, however, prohibited its use. therefore, the USS Forrestal (CVA-59) was selected and tests were planned and conducted during the first two weeks of December, 1957. The test specification used was the joint effort of BuShips, BuOrd, BuMed and ONR. The results from this test were incomplete due to the complexity of the problems involved and the limited time available for testing. However, certain useful information was obtained regarding the magnitudes of r-f fields at various locations on the ship. For instance, it was learned that the fields laid down on the flight deck by the ship's own radar mounted on the island structure were on the order of 40 to 50 db below the tolerable level of  $10 \text{ mw/cm}^2$  established by BuMed for microwave radiation.

A second series of tests, conducted as a Fleet Assist Project, was made aboard the USS Frankling D. Roosevelt during the period of 16 to 21 April 1958. A large portion of the testing was devoted to ordnance which included missiles of various types. Many of these missiles were instrumented with thermocouples and bridge

elements replacing the sensitive elements normally installed in the weapons. A result obtained from these tests was the firing of a rocket installed in a rocket pod when it was exposed to the r-f field in the vicinity of the TBA antenna. Other information obtained from these tests will be available after all the data has been analyzed.

Measurements of voltage and currents from aircraft structure to ground were made relative to the ordnance and gasoline hazard tests. These tests were generally made with the aircraft positioned as closely as possible to the transmitting whip antenna. As previously stated voltages as high as 300 volts and currents over 1 ampere were measured. A small explosive vapor test device was also used in conjunction with the voltage and current readings and could be fired with voltage-current products as low as 50 volt-amperes. Visible sparks were observed down to 6 volt-amperes.

An important aspect of these tests was the measurement of the magnitude of the fields which illuminated, the missile, weapon or plane under test. Fields generated by communications transmitters operating below 25 mc. were measured by a modified AN/PRM-1 Field Intensity Meter. The modification consisted primarily of a shielded enclosure for the instrument to eliminate case penetration and attenuators in the loop and rod input circuits to extend the range of voltages measured. Since measurements were made in the induction field, both "E" and "H" components were measured. An example of the fields measured is shown by the following readings. With the TBA antenna in the "up" position, the field at a distance of 24 feet from the antenna was:

$$"E" = 22.2 \frac{\text{volts}}{\text{meter}}$$

$$"H" = 3.71 \times 10^{-3} \frac{\text{ampere turns}}{\text{meter}}$$

Power density measurements were made in the frequency range of 200 to 10,000 mc. using a system illustrated by Figure 1. The technique used here is to measure the average power delivered to a thermistor element used as an arm of a power bridge circuit. The energy is picked up by an antenna with a known capture area and delivered to the thermistor via cables or attenuators with known attenuation characteristics. Correcting the meter reading for this attenuation and dividing the results by the effective area of the pickup antenna gives the power density value for the field. As this is the average power density field, the peak value may be obtained by dividing by the duty cycle of the radar whose field is being measured. A volts-per-meter value for the field intensity may be obtained from either the average or peak power density field by the following expression:

$$E = \sqrt{377} (\text{Power Density})$$

It is assumed, of course, that measurements will be made at least 2 wavelengths distance from the radiating antenna which will probably be the case for the frequency range under consideration. The lower limits of average power density that can be measured by such a system range from  $6.7 \times 10^{-6}$  mw/cm<sup>2</sup> at 200 mc to  $2.6 \times 10^{-3}$  mw/cm<sup>2</sup> at 10,000 mc. The upper limits depend on the degree and power handling capabilities of the attenuators available. It is believed that the system will handle all the radars in operation at present and those in the immediate foreseeable future.

FIGURE I

POWER DENSITY MEASUREMENT SYSTEMS

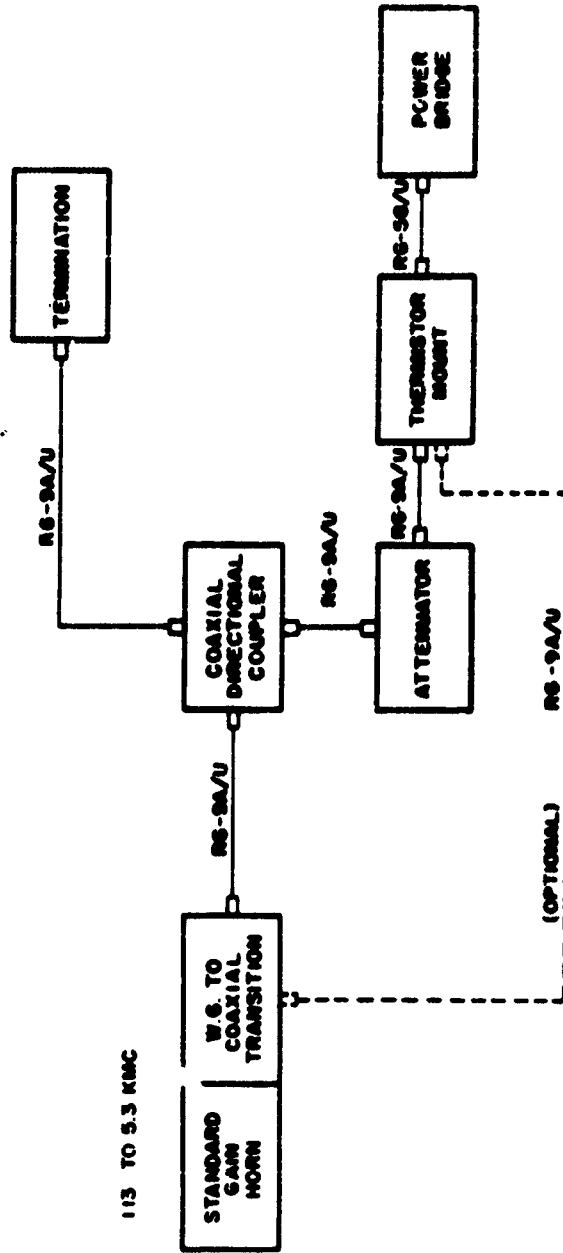

5.3 TO 12.4 KMC



MICROWAVE RADIATION HAZARDS PROBLEMS  
IN THE U. S. ARMY

by

Lloyd C. MacMurray, Lt. Col., MSC  
U. S. Army Environmental Health Laboratory

COLONEL KNAUF:

One of the most enthusiastic and tireless workers in this chase for data on the microwave hazards problem has been Lieutenant Colonel Lloyd MacMurray of the U. S. Army Environmental Health Laboratory.

Colonel MacMurray is a human dynamo. He has applied himself in a truly astounding manner to the problem of understanding the theoretical aspects of the microwave problem.

At the same time he has rolled up his sleeves and gone into the field to conduct his own surveys. He has mastered the techniques involved in the instrumentation field.

I am not sure just what the subject of his talk today actually concerns, but I am sure that if he has a problem that is causing him trouble with his work in the Army, we should listen carefully for it will not be an easy one to solve.

COLONEL MACMURRAY:

This presentation will consist of a discussion of the Army problems and activities related to the health hazards of microwave radiation resulting from Army operations. The following items will be covered: (1) the problem, how and where it occurs; (2) the criteria for determining potential health hazards; (3) the biological study program; (4) the occupational health control program.

Potential health hazards from microwave radiation exist for the Army in three frequently occurring situations. These are:--  
(1) the use of radar in air defense systems, missile control and other field operations; (2) the training of personnel for assignment

to these field operations; (3) research and development work on fire control systems.

In the first situation a relatively small number of radar sets are grouped at a site. The equipment will include various combinations of target acquisition, target tracking and missile tracking sets. The selection of the site for the operation and the method of organizing the ground will depend primarily on the mission of the unit and only secondarily on health protection. In general, a potential as versus proven health hazards may exist for all personnel assigned to the unit including not only radar operators, but the firing and launching personnel and service and administrative sections. Beyond the confining of the site, adjacent civil and military populations may fall within the zone of measurably microwave power fields.

In the second situation there are a large number of standard sets located as closely together as possible at service schools for training large numbers of technicians. The selection of present sites for field training has usually been based on the convenience of the school staff and the availability of suitable terrain. Potential hazards may exist for the trainees on the radar equipment school teaching staff personnel at adjacent training sites and administrative, clerical and service personnel.

In the third situation a limited number of experimental sets minus the radiator are located in relatively confined laboratory spaces. A potential hazard may exist for the project scientists and members of their group; others within the specific laboratory,

frequency categories established, it is believed the present criteria are adequate for the interim period.

#### BIOLOGICAL STUDY PROGRAM

The U. S. Army has entered the field of research on the biological effects of microwaves in the past few months with a study program. This will be carried on in the Physical Medicine Branch of the Army Medical Research Laboratory at Fort Knox, Kentucky. The new Microwave Radiation Section is now being staffed, housed and equipped. Its program is being planned around research into the basic phenomena of biological response to microwave radiation as a long-term project.

The Army Medical Research Laboratory is not new to the field of thermal heat. It has a continuing program in the study of the physiological and psychological response to both heat and cold. The facilities and scientific personnel engaged in this closely allied field are available to support our new microwave program.

#### OCCUPATIONAL HEALTH CONTROL

The occupational health control program of the U. S. Army, while still in its infancy, is more advanced than the biological research program.

During the year since the last Tri-Service Symposium, here we have progressed in the following categories of activity: (1) instrumentation, (2) acquisition of experience data, (3) development of investigational methods, (4) information and education.

frequent visitors to the laboratory such as supervisors or service personnel, and transient visitors to the laboratory such as visiting scientists.

The term potential health hazard is used in this presentation to describe only the possibility, not the probability of exposure of personnel to undesirable power density levels. Undesirable power density levels, in turn, refers to the upper limits of safe exposure and not to the levels at which biological damage may occur. And the levels at which biological damage may occur are threshold limits of exposure at which damage may be suspected, not levels at which biological damage is certain to occur.

#### HAZARDS CRITERIA

The U. S. Army has adopted the tentative criteria of 0.01 watts/cm<sup>2</sup> as being the upper limit of safe exposure to microwave radiation. How this criteria applies to various frequencies, beam width, lengths of exposure, areas and portions of the body presented to the beam, and the effect of multiple sources of radiation will be considered in a later portion of this presentation. Open wave guides and feed horns, during Army transmission of signals, are also considered hazardous because the power densities are usually high.

These are tentative criteria for reasons well known to this audience. The state of the art today is one of immaturity. In general, it is felt that under present conditions of exposure reasonable and suitable personnel protection is obtained. Even as more data is adduced in support of change, and as a result the criteria must be revised in the future with lower or higher limits, or



## Instrumentation

In October of 1957 the Office of the Surgeon General was called on to brief the Office of Research and Development, Department of the Army, on the health hazards associated with microwave radiation. We emphasized at that session the inadequacies of instrumentation most suitable for evaluation of microwave working environments. Specifically, we recommended that the Army, irrespective of work done by other services, take the necessary steps to obtain three kinds of equipment. These were described as follows: Monitoring equipment for location of hot spots in power fields; and we suggested that the monitoring equipment should be light, portable, battery operated, and equipped with protected attenuators and cut-outs to protect the instrument against damage in fields of high power levels. The second piece of equipment was survey equipment. We specified that the survey equipment should give reliable reproducible results, be reasonable in cost, simple to operate, and durable for field use. The third piece of equipment is the personnel warning device. This would be a device which would warn a person with a visual or audial response when he enters a microwave power field with the potentially hazardous level of heating. This should be comfortable to wear, cheap, have a long shelf life and a rapid response rate.

As a result of this briefing, the Office of the Surgeon General and the Signal Corps were directed to submit essential and military characteristics for microwave measuring equipment. Unilateral discussions were held with a representative of the Signal

Corps and the Fire Control Instrument Development Groups of Ordnance Corps; and in November a joint informal conference was held at Fort Monmouth under the joint sponsorship of the U. S. Army Research and Development Laboratories (formerly, U. S. Army Signal Engineering Laboratories) and the Army Environmental Health Laboratory. Agreement was reached on the types of equipment needed and two sets of military characteristics were submitted, one representing the medical concept and the other the Signal Corps' instrumentation concept. These are now circulating for comment and review throughout the Army.

#### Acquisition Experience Data

During the year a considerable amount of data has flowed into the files of the Army Environmental Health Laboratory on various theoretical calculations and actual measured values made on the field strengths from a variety of radar sets. The laboratory also received several requests to evaluate the microwave environment at various installations and sites.

After studying with the Fire Control Division at Aberdeen Proving Grounds these data and the requirements being laid upon the laboratory, it was decided to organize a research project directed toward developing by 30 June 1959 an experience data handbook. It was proposed that this would consist of a collection and evaluation of known data on all sets in which the Army had an interest. It would include theoretical calculations, measurements from towers, and field measurements at sites. These data would be related to specific power outputs and frequencies. This handbook, we hope,

will be useful in predicting performance of sets in advance and in extrapolating the data to hypothesize as to the problem performance of sets not now built.

A small amount of research and development money was obtained near the close of the fiscal year and a contract given to Aberdeen Proving Grounds to start this work.

#### Development of Investigative Method

As an initial test of our investigative skills, measurements were made last month at one of the Army training installations. Here a large number of acquisition and tracking radars are concentrated in a small area adjacent to a classroom building. At the conclusion of the presentation some graphic aids will be shown of the problem, the investigative method, and the instrumentation of a training site illustrating measurements of acquisition and track tripod sites. (The figures were not reproducible with clarity and hence were omitted. Editors.)

As a result of this study, we have arrived at some generalized criteria that we believe should be applied to training situations. They are as follows:

- a. Hard stand areas should be limited to the immediate vicinity of the set, providing only adequate space for trainees.
- b. Surfaces between sets should be soft and absorbing, preferably grass.
- c. Sets should be separated by predetermined distances to reduce search-lighting exposures to less than 10 milliwatts per square centimeter at successive sets.

- d. Training areas around sets that may be search-lighted by acquisition type radar should be screened in the direction of the beam.
- e. Rest areas should be provided for trainees at distances where the power densities are less than 1 milliwatt per square centimeter.
- f. No other unassociated type of training shall be done in the vicinity.

We believe that under today's conditions the training sites will be reasonably small and manageable and not impose a hardship.

#### Education and Information

Interest in microwave radiation and its potential health hazards is very high. A rather haphazard but continuous effort has been carried on by the U. S. Army Environmental Health Laboratory and the Office of the Surgeon General to meet requests for information on the subject. Many informal briefings and seminars have been conducted, including discussions with physicists and electronic engineers in the Ordnance and Signal Corps. Two formal papers were presented: (1) to the U. S. Army Preventive Medicine Officers and Sanitary Engineers at a training course held at Edgewood in April, and, (2) to the Association of Governmental Industrial Hygienists at the annual Occupational Health Conference at Atlantic City. At both of these presentations the audience response was one of great interest in the subject. We also shared the platform with Colonel Knauf at a meeting in March of the Joint Commission on Environmental Sanitation Diseases of the Armed Forces Epidemiological Board.

There is considerable need for placing before national scientific societies generalized papers on the subject to broaden the base of knowledge of medical people and allied scientists. This is,

of course, in addition to the requirement of all of us to maintain a continuing flow of detailed technical unclassified literature from the excellent and intensive research program being carried on by the Armed Services, university contractors, and independent research groups.

#### SUMMARY

In reviewing this paper for summary points, I found it somewhat lacking in systematic organization. This, I believe, reflects the irregular growing edge of the Army's interest and work on the problem. We have had limited resources, particularly human resources, during the fiscal year of 1958. In general we have made progress in:

1. Analyzing the operational problem,
2. Defining the Army role in biological effects research,
3. Preparing clear-cut instrument requirements,
4. Developing occupation health control concepts,
5. Developing an initial competency in evaluating microwave radiation working environments,
6. Obtaining first-rate cooperation between all Army technical services concerned,
7. Acquiring new respect and confidence in our sister services, the Navy and Air Force, because of their demonstrated accomplishments in the field.

## PEARL-CHAIN FORMATION

by

J. F. Herrick, Ph. D., Mayo Clinic and Mayo Foundation\*  
(With the Technical Assistance of John Howell)

### COLONEL KNAUF:

A couple of years ago our higher headquarters in the research command organized an Ad Hoc Committee to come to Rome to look over the work we were doing in this hazards field. At the sessions of that group, I made some real friends. Several members of the original group are with us today. Outstanding among the valuable friends I acquired by way of that committee was Dr. Julia Herrick, of the Mayo Foundation.

Dr. Herrick is a diligent worker herself in the field of bio-electric effects and has written some of the finest papers that grace the literature on this subject.

The subject of her talk today is fascinating. Dr. Herrick is an investigator possessed of vision and I have looked forward eagerly to hearing what she has to say.

It is a pleasure to introduce Dr. Julia Herrick.

### DR. HERRICK:

The phenomenon known as "pearl-chain formation" was described in the German literature as early as 1927 by Muth,<sup>1</sup> who referred to it as Perlschnurkettenbildung.\*\* A thorough search of the literature has not been made. An interesting account of this phenomenon may be obtained in a chapter by Schwan<sup>2</sup> on the "Biophysics of Diathermy" in a recent book edited by Licht, entitled Therapeutic Heat.

---

\* The Mayo Foundation, Rochester, Minnesota, is a part of the Graduate School of the University of Minnesota.

\*\* It is interesting to note that similar chain formations have been observed in magnetic fields and also in electrostatic fields: Thomson, Elihu: A Novel Magneto-Optical Effect. Nature. 107: 520-522 (June 23) 1921; Whytlaw-Gray, R. and Speakman, J. B.: A Novel Magneto-Optical Effect. Nature. 107:619 (July 14) 1921.

The phenomenon was used by colloid chemists when they studied certain characteristics of colloidal particles. It is understood, also, that electrical engineers were familiar with pearl-chain formation.

This phenomenon can be demonstrated readily by passing an alternating current through water containing drops of oil. The oil droplets fall into chains which closely resemble chains of pearls. Before the alternating current is turned on the oil droplets are in a random distribution, as shown in figure 1a. Figure 1b shows the pearl-chain formation which takes place almost immediately after application of the alternating current. The frequency employed in this instance was 27 megacycles per second, pulsed at a repetition rate of 80 per second. When the alternating current is turned off the oil droplets return to the previous random distribution, as seen in figure 1a. This experiment can be repeated indefinitely, provided there is not enough energy to produce thermal effects. The particular chamber which we used in our pearl-chain experiments was very similar to that described in a paper by Blüh,<sup>3</sup> and will not be described in this report.

Ever since alternating currents have been used for medical diathermy, the question has arisen repeatedly: Are there nonthermal effects? The fundamental purpose of the clinical introduction of alternating currents is to increase the temperature of bodily tissues to values desired for therapy. Many able investigators have attempted to answer the foregoing question by means of careful studies, and the general conclusion as stated by Scott<sup>4</sup> is:

"The therapeutic effects of short-wave diathermy are, therefore, regarded as being solely due to the heating effect." Obviously, the intensities of electrical energy used for medical diathermy would not be suitable for demonstrating pearl-chain formation until absorption by the bodily tissues had reduced the energy to a level at which such a phenomenon could occur.

Pearl-chain formation may be considered as a nonthermal effect. Liebesny<sup>5</sup> reported the phenomenon of pearl-chain formation in milk and in human blood to the International Congress for Short Waves held in Vienna in 1937. It is necessary to dilute both milk and blood when pearl-chain formations are to be demonstrated, because the cellular elements are too numerous when not diluted.

Throughout the many years we have been studying the biologic effects of high-frequency alternating currents, we were not aware of the phenomenon of pearl-chain formation. Our attention was directed to this phenomenon through the kindness of Dr. A. J. Ginsberg, of the Diapulse Corporation, and Colonel George M. Knauf, of the Griffiss Air Force Base. In August, 1957, Dr. Ginsberg brought the equipment called the "diapulse machine" to our laboratory for experimental evaluation. The diapulse machine is a pulsed generator which has a frequency of  $\approx 7$  megacycles. The generator is designed to produce pulses of various repetition rates. Pearl-chain formations in both milk and blood can be produced readily by this pulsed generator, provided the output is low enough to cause no heating effect.



After perfecting our technic for demonstrating pearl-chain formations in diluted milk and in diluted blood with the diapulse machine, we wished to observe the same phenomenon with a continuous short-wave generator. We obtained a 27-megacycle diathermy machine from the Section of Physical Medicine and Rehabilitation of the Mayo Clinic and were able to demonstrate pearl-chain formations very readily, provided the energy level was sufficiently low. Figure 2 shows the pearl-chain formations formed by the fat globules in diluted milk when the continuous-wave generator just described was used.

Moving pictures of pearl-chain formations are excellent for demonstrating the smooth transitions from the state of random distribution of the cellular elements to the formation of chains. A particularly interesting observation which occurs in the early stages of the return to random distribution can be demonstrated most convincingly by the moving film. When the current is turned off, the chain immediately becomes distorted into curvilinear forms. If the electrical energy is turned on again at this stage, the chain straightens out almost instantaneously, exactly as if the "thread" on which the "pearls" were strung had been suddenly pulled taut. This observation can be repeated indefinitely as long as the thermal effects are negligible.

Once we had confirmed the work of previous investigators, it was a logical sequence to look for pearl-chain formations in other physiologic fluids which contain cellular elements. Lymph was the first fluid selected for study (fig. 3a and b). Figure 3b shows the

random distribution of the cellular elements of lymph before the alternating current is applied. Observations on other physiologic fluids have not been completed, and no report will be given at this time. We regret the preliminary nature of this report at a time when several aspects for further study present themselves such as:

1. Is the phenomenon of pearl-chain formation dependent on the frequency of the applied alternating current?
2. Does the phenomenon occur in the living animal?
3. Is there a possible therapeutic effect associated with pearl-chain formations?

The objective of this report is to share these preliminary observations with other workers and to direct the attention of those who are unfamiliar with pearl-chain formations to a nonthermal effect of alternating currents. Previous investigators in the field of medicine who have studied pearl-chain formations claim no therapeutic effect for the phenomenon. It is hoped that additional investigations may lead to more interesting results. All that can be said conclusively at this time is that the cellular constituents of blood and lymph assume a pearl-chain formation in vitro when alternating currents are applied properly.

Grateful acknowledgment is given to Dr. Khalil G. Wakim and to Dr. Albertus Wildervanck whose suggestions and assistance made this study possible.

## REFERENCES

1. Muth, Ernst: Über die Erscheinung der Perischnurkettenbildung von Emulsionsparticelchen unter Einwirkung eines Wechselfeldes. Kolloid Ztschr. 41:97-102, 1927.
2. Schwan, H. P.: Biophysics of Diathermy. In Licht, Sidney: Therapeutic Heat, New Haven, Connecticut, Elizabeth Licht, Publisher, 1958, pp. 55-115.
3. Blüh, Otto: Einige bei der Untersuchung von Kolloiden im Wechselfeld auftretende Erscheinungen. Kolloid Ztschr. 37:267-270 (Nov.) 1925.
4. Scott, B. O.: The Principles and Practice of Diathermy. Springfield, Charles C. Thomas, 1957, 193 pp.
5. Liebesny, P.: Athermic Short Wave Therapy. Arch. phys. Therap. 19:736-740 (Dec.) 1938.



Fig. 1. Pearl-chain formations in a mixture of oil and water: **a** shows the random distribution of oil droplets before the current is turned on; **b** shows the pearl-chain formation which occurs when a pulsating alternating current is turned on. The frequency is 27 Mc and the repetition rate of the pulses is 80 per second.

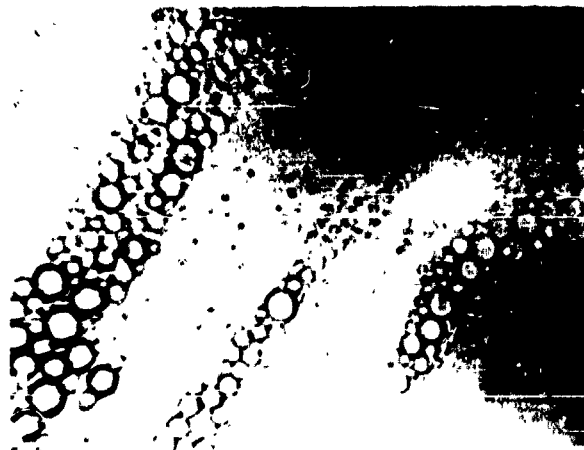

**Fig. 2.** Pearl-chain formation in diluted milk when a continuous-wave diathermy machine was used as the source of energy. Frequency was 27 Mc.



Fig. 3. Pearl-chain formations in undiluted lymph: a is the control, showing random distribution of the cellular elements; b shows the pearl-chain formations which result when the alternating current is applied. (Conducted under the same conditions as those stated in Figure 1.)

FIELD TRIAL OF RICHARDSON  
MICROWAVE DOSIMETERS

By

Thomas S. Ely, M. D.

COLONEL KNAUF:

One of the most pressing problems in our approach to the microwave hazards problem is concerned with the development of an adequate personnel detector.

We are fortunate in having with us Dr. Thomas Ely, representing the Bureau of Medicine, United States Navy, who will discuss his experience with one such device. Dr. Ely is no doubt known to most of you by way of his excellent work on 10 cm waves done at the Naval Medical Research Institute.

He is exceptionally well qualified to discuss this problem for us and I am sure will have valuable advice for those involved in the development or use of such a device.

DR. ELY:

Introduction

As part of the RF Hazards Evaluation aboard the U. S. S. Forrestal, an evaluation of the Richardson Microwave Dosimeters under field conditions was made. This report summarizes the evaluation. It should be understood that it treats factors peculiar to field use; little calibration was attempted or possible. Calibration is, of course, a laboratory job.

Description

Figure 1 shows four dosimeters. They are essentially miniature, self-

---

\* Editors note: See Appendix A immediately following Figure 1 for an interesting evaluation of biological hazards from RF fields aboard the U. S. S. Forrestal by Dr. Ely.

contained electronic thermometers, which indicate the temperature of a small mass of gelatin. This is accomplished by a thermistor, one or two stage DC transistor amplifier, and meter. The gelatin mass simulates an avascular body structure which, principally because of its water content, is heated by an electromagnetic field.

### Field Results

Readings in RF Fields are given in Table I. Although not to be construed as calibration, the field strength of the AN/APS-20E Radar at the dosimeter location was probably roughly .00 mw/cm<sup>2</sup>.

Table I

Radar	Location	Reading
AN/APS-20E	On axis of reflected beam with antenna stopped	Half scale - fast component. Off scale at right - fast and slow component.
AN/SPG-48	As close to feed horn as possible	0
HK. 35	do.	0
AN/SPS-8A	On axis of reflected beam 25' away with antenna stopped	0
do.	As close to feed horn as possible	0
Low frequency 8030 Kc.	A few feet from long wire antenna	0



One of the first things to become apparent about the dosimeters is their ambient temperature sensitivity. A large change in reading occurred when the instrument was moved from indoors to outdoors or vice versa, from tabletop to hand, or from one pocket to another. As an experiment, the #1 dosimeter was allowed to reach thermal equilibrium in three locations with readings as given in Table II.

Table II

Location	Reading ( $\mu$ a)
Table top indoors	100 (center of scale)
Shirt pocket (under parka) outdoors	pegged to right
Parka pocket outdoors	pegged to left

This is without RF field, of course. Inside air temperature was about 20° C. and outside about 5° C.

One unexpected effect should be mentioned. In the highest field available, that of the AN/APS-20E, the #1 dosimeter lit up brightly from internal sparking between the various conductive parts of the instrument, although this had no apparent immediate effect on function. This radar is pulsed; the effect would probably not occur with a CW radar of the same average power field.

An approximate determination of the thermal time constant was made by warming the gelatin capsule, and then plotting a cooling curve on log-linear paper. Time constant is to the base e, in other words, the time

required to reach  $1/e$  of the original value. By this method, dosimeter #1 had a value of approximately 6 minutes, or 360 seconds, and dosimeter #2 had a value of 6.5 minutes, or 390 seconds.

#### Evaluation

It appeared that the dosimeter tested was a functional prototype, providing definite indication on a meter when in an RF field of sufficient strength. It was simple enough mechanically and electrically to be fairly inexpensive and reliable as a production item.

The overriding shortcoming of the dosimeters in their present form is the ambient temperature sensitivity. When shifting the instrument from one pocket to another produces a greater change than a significant microwave field, it is difficult to monitor the latter with the instrument.

The instrument tested had a fast and a slow time constant. The fast component is due to RF energy picked up by the wiring, conducted into the thermistor, there being converted to heat, and this heat being dissipated into the surrounding cool gelatin. The slow component results from the RF energy being picked up by and being converted to heat in the gelatin and this heat being dissipated mainly by air convection around the capsule. In practice, and within limits, these two time constants result in a "rate" and "dose" reading. Either or both of these may be emphasized by appropriate design. The six minute slow component is in the range of biological significance.

Although the internal sparking observed did not appear to affect function, it likely would result in some destruction if given time. Elimination of this should simply be a matter of some additional insula-

tion and/or shielding.

Suggestions

1. Ambient temperature compensation should be provided. This could take the form of a reasonably well matched thermistor in a mass similar in heat capacity and size to the gelatin capsule, but of low dielectric loss.
2. Measures should be taken to prevent internal sparking. This could probably be accomplished without shielding against the fast component if this is desired.
3. Laboratory calibration should be done. This should consider and relate field strength, polarization, duty cycle, wavelength, ambient temperature, position of dosimeter, and time, to reading.

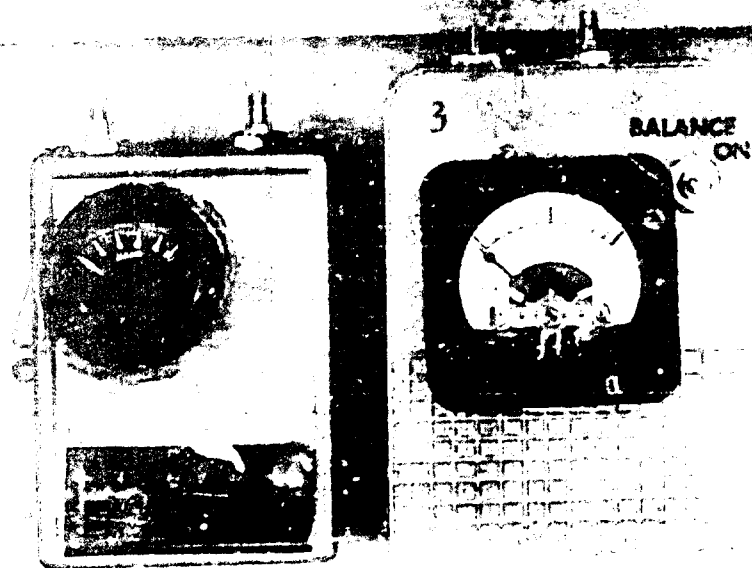

Figure 1

Best Available Copy

BRIEF EVALUATION OF BIOLOGICAL HAZARD FROM  
RF FIELDS ABOARD THE U.S.S. FORRESTAL

By

Thomas S. Ely, M. D.

Introduction

A consideration of the biological hazard must be based on biological standards. There is reasonable good agreement between the maximum permissible levels suggested by the Armed Forces, Schwan and Li,<sup>1/</sup> and Ely and Goldman.<sup>2/</sup> These are summarized in Table I.

Table I

<u>Source</u>	<u>Frequency</u>	<u>Structure</u>	<u>Level</u>	
			<u>Short Exposure</u>	<u>Continuous Exposure</u>
Armed Forces	Any	---	---	10 mw/cm <sup>2</sup>
Schwan & Li	<1000 Mc	Whole body	>0.3 w-min/cm <sup>2</sup>	30 mw/cm <sup>2</sup>
	1000-3000 Mc	Whole body	0.3 w-min/cm <sup>2</sup>	10 mw/cm <sup>2</sup>
	>3000 Mc	Whole body	<0.3 w-min/cm <sup>2</sup>	20 mw/cm <sup>2</sup>
Ely & Goldman	3000 Mc	Whole body	50 w-sec/cm <sup>2</sup>	100 mw/cm <sup>2</sup>
	3000 Mc	Eye	17 w-sec/cm <sup>2</sup>	150 mw/cm <sup>2</sup>
	3000 Mc	Testis	1.3 w-sec/cm <sup>2</sup>	5 mw/cm <sup>2</sup>

Schwan also gives a value 0.01 watt hour/cm<sup>2</sup> for short exposures to 3000 Mc. microwaves. This is twice the figure in the table, but prob-

<sup>1/</sup> Schwan, H. P. and Li, K.: Hazards Due to Total Body Irradiation by Radar, Proceedings of the I. R. E., 44:1572-1581, November 1956.

<sup>2/</sup> Ely, T. S., and Goldman, D. E.: Heating Characteristics of Laboratory Animals Exposed to Ten-Centimeter Microwaves, Research Report Project NRI 001 056.13.02, Naval Medical Research Institute, 21 March 1957.

ably applies to somewhat longer times of exposure. The short exposure whole body value of Ely and Goldman was intended to apply to times measured in minutes rather than seconds.

#### Findings

Examination of the field strengths determined by measurement promptly discloses that the only fields which were significant in terms of the suggested permissible levels were those from the AN/APS-20E airborne radar while the aircraft was on the flight deck, radiating with a stationary antenna. The values were 14  $\text{mw}/\text{cm}^2$  at 25 feet and 70  $\text{mw}/\text{cm}^2$  at 16 feet. Somewhat, although not greatly higher values would be expected at closer range. Standard operating procedure for this radar calls for use of a dummy load until the unit is airborne, and rotation or sectoring of the antenna when radiating. The test conditions were artificial and field strengths of this magnitude would not be expected under normal operation.

All other measured fields were very low. With the exception of the APS-20, the only higher power radar antenna were high above flight deck level on the island structure. Personnel exposures close to these antennas would be unlikely or almost impossible due to their location, and the environmental hazard due to stack gas would probably be overriding in any case.

#### Conclusion

It is concluded that personnel damage from RF fields aboard the U.S.S. Forrestal would be extremely unlikely, and could result only from an improbable combination of unfortunate events, deviations from the standard operating procedure, and intent.

HUMAN ENGINEERING APPLICATIONS  
AS RELATED TO PERSONNEL PROTECTION

by

Anthony Debons, Lt Col, USAF  
Human Engineering Laboratory, RADC

COLONEL KNAUF:

In my opening remarks I made reference to the fact that human engineering can play an important part in helping us cope with the microwave hazards problem. All too often we are faced with a serious hazard in this field only because the human engineers were not consulted during the design phase of the piece of equipment.

I am forced to wonder sometimes whether we all realize the enormous help these folks can provide. For this reason I have asked Lt. Col. Debons, the Chief of our Human Engineering Laboratory, to discuss the services his activity is in a position to provide with the thought that his presentation may serve to stimulate your thinking along these lines.

LT COL DEBONS:

I come to you with considerable enthusiasm for human engineering because I feel that we may be now on the threshold of realizing the importance of considering man in the design of equipment. I think we are still in the hangover stage, however. For the past 100 years our culture has not realized the practical significance of the exploratory work of the late 19th century psychologists, physiologists, and physicians who were concerned with understanding in a scientific way the nature of man's function to the environment about him. I am afraid that by and large our culture still accepts the old notion that there is too much variability in man, too much uncertainty in the prediction of behavior to be able to apply evidence from a study of man to his control in real life situations.

I would like to suggest to you, however, that we may now have reached a point, at least in the Armed Forces, where this is not the case. I am happy to say that there are now established within the services, organizations whose missions are specifically directed at recognizing man's role in the working environment. I think our present preoccupation, for example, with the man in Space is centered around the problem of where does the man fit into the mission complex, how well will he perform, how will he react in the new environment, how can he survive, and how can we provide him with the proper tools for his return to earth. Certainly these tools will have to be compatible with the limitations imposed upon him by the equipment and with the drastically altered environment that he must face.

I mentioned before that the work of the 19th century scholars and scientists was significant in getting us to think about man's behavior beyond that of being just the result of chance. It was significant because they attempted to quantify human behavior. They saw no reasons why scientific methodology could not be applied to the study of man's behavior as well as his physical environment. Their preoccupation in a quantitative sense with man's sensory and motor mechanisms is fortunate because much of this information available to us today provides the basis for much of the philosophy and techniques used in present human factors work. Human factors consists of a cross-disciplinary endeavor; the anthropologists, psychologists, physiologists, mathematicians, and physicians are all contributing to the human factor analysis. Alike their



predecessors of the 19th century, all of these people are concerned with the quantification of human functions. Each of these perform human engineering functions when as a team they concern themselves with man's reactions to the stimulations provided by the physical environment. They consider other environments, internal and social, that may account for man-machine performance. They integrate the total body of information in this analysis to achieve the optimum relationship between the man and the machine. They achieve this objective by first describing man's capabilities and limitations. Secondly, he analyzes the nature of the task. He goes into great detail about this. He determines what conditions the man is subjected to and what actions he is to take in relation to these particular conditions, and finally, his function is to analyze the specific equipment the man must operate.

Now I have taken the liberty of somewhat diverting the title of the paper that Colonel Knauf requested me to talk to you about this afternoon. Personnel protection represents a very segmented area in human engineering. I would like to consider human engineering in a broader context, and in this way provide you with a basis to consider the implications to the problem of personnel protection. As such, I would like to describe briefly to you the human engineer's preoccupations and how he goes about resolving the critical aspects of these preoccupations. Secondly, I would like to cite specific examples where inadequate provision for human engineering led to serious expenditure of personnel, equipment, money and resources. Some of the implications to be derived from these comments can be easily applied to the problem of personnel protection.

7

There are three essential functions of the human organism that relate to man-machine analysis. The first of these concerns the motor functions. Such things as dexterity, rotational features of knobs and dials, discriminable movements on control mechanisms are some of the considerations in the design of equipment. Secondly, he is interested in the sensory functions of man. In this respect he is interested in the limits of functioning of the visual, auditory, olfactory and other sensory modalities. And further, he is interested in learning capabilities of the human organism; that is, the capacity of the individual to retain information and to respond rationally time after time to the same or different situations, filtering in past as well as new experiences into his repertoire of information.

Considerable work in all these areas has been done by various human engineering organizations throughout ARDC. For example, WADC has made extensive studies of tracking performance. The amount of error allowable under certain operational conditions has been specified. Information is now available concerning the control configuration to afford the least amount of tracking error. This important function has been well described, and we know more about tracking now than ever before. The human engineer is now able to consider the tracking function as related to specific equipments and come up with life and time-saving suggestions in the design of the equipment our Armed Forces need. This is only one small example. Other aspects of motor functions, such as steadiness, force rhythm, have been and are continuing to come under the

7

scrutiny of the human engineer. In each of these we are attempting to quantify man's performance in respect to the equipment he uses. The more we understand the functional relations between man and machine, the more we provide added safety to our operating personnel. If we ignore the importance of this work, as Colonel Knauf has well stated in the introduction, then wasteful errors and duplication of these errors will result.

As far as the sensory functions are concerned, there are a number of things that merit consideration. All of us are aware of the important work on dark adaptation during the last war. As an extension of this, I would like to refer to the Army Chemical Laboratory's work on the influence of various drugs on the dark adaptation function. In the event of use of chemicals by the enemy in any future war this information will be of inestimable value to the services in preventing casualties at a time when these casualties can be less tolerated. In the area of audition the question of how many auditory signals can be provided and at the same time maintain maximum alertness to signals has been an important human engineering problem. The question of parcelling auditory and visual signals to prevent overloading on one of the sense modalities is a continuing problem. Furthermore, the character of the visual or auditory signal that we provide the operator is of importance. Let's consider the case of the Navy pilot who was making an approach landing with his landing gear retracted. The control tower personnel realized the situation and attempted to alert the pilot to the situation by reiterating over the intercom system, "Put your landing

gear down!" The control tower personnel continued issuing these instructions without avail. The pilot landed his aircraft with landing gear retracted. Fortunately, he was one of the pilots who survived to tell the story. And the facts in the case were that while the pilot was attending to a number of warning signals such as loud noises of cockpit horns, bells, and what have you, the voice of the control tower operator frantically issuing instructions to him over the intercom went unheeded. This represents only one of many incidences that I could cite here in support of the importance of carefully assessing the environment within which your operator is to function when you design the equipment about him.

I mentioned previously that the human engineer is interested in man's learning capabilities. I believe in this one we have an important morale to obtain. Once you have designed the equipment to suit man's capabilities and once you have taught him to operate the equipment, one further important thing remains. You must provide both for the preservation and variation of the learned behavior. This means that the human engineer is confronted with a subtle dimension in the design of equipment. Once we have estimated what man is capable of responding to and once we have taught him to respond to these things appropriately, one further thing remains, and that is to establish the mechanisms in the environment which will sustain this behavior under varying conditions.

Just one other thing before closing. I mentioned that the human engineering function involves the understanding of man, the equipment and task. The end result is the best relationship between

man and the utilization of equipment. The growth of human engineering is related directly to the needs and interests of the people who use the equipment in the field. This, in turn, is directly related to the recognition in all users that human behavior is predictable and the human engineering could insure him a more efficient as well as a safer world in which to live.

## MEDICAL CONSIDERATIONS OF EXPOSURE TO MICROWAVES (RADAR)\*

by

Charles I. Barron, M.D., and Albert A. Baraff, M.D.  
Medical Department, Lockheed Aircraft Corporation  
Burbank, California

### COLONEL KNAUF:

My introduction to the overall problem of possible microwave effects came by way of a paper written on the West Coast by a man engaged in the practice of industrial medicine in the aircraft industry. I have since come to respect and admire this individual as an outstanding figure in the field of industrial medicine and one who has made a very real contribution to the effort of solving the radar hazards problem. The man I refer to is Dr. Charles Barron of the Lockheed Aircraft Corporation. Until two days ago, Dr. Barron had planned to be with us at this meeting. However, on Saturday morning he informed me by telephone that he would be forced to cancel his plans to come to Rome. He has given me permission to introduce his paper by title to our meeting and to refer to it in the report of our proceedings. Dr. Barron has sent us a copy of his paper, "Medical Considerations of Exposure to Microwaves (Radar)," presented at the AMA meeting last month, and which I am indeed pleased to introduce at this time.

Because Dr. Barron's findings are so much in keeping with the results of our research to date and since he so eloquently points out the pitfalls in attempting to extrapolate small animal findings in predicting effects on man, I would like to read his Comments and his Summary as they appear in this paper.

I feel this group should go on record as expressing our appreciation for the clear and factual picture Dr. Barron has painted for us of the situation as he sees it in relation to airborne radar.

### COMMENTS (Dr. Barron)

During the past 18 years thousands of people, in the course of their employment or while in military service, have been exposed to microwaves, many without protection. Concern over the effects of

\*Presented at the Scientific Assembly of the American Medical Association, San Francisco, Calif., June 23-27, 1958.

such exposure is natural and to be expected. The majority of radars in common use today are relatively low powered, with the exception of some military transmitters which exceed 1 megawatt peak power output. Radars with many times this power will be operational in due course, and may radically change our entire concept of the biological potentials of this form of energy. Since microwaves of varying frequency and power output are also being used to provide television display, for diathermy, and in electronic ovens, the personal safety problem is one of general public interest.

Experiments to date have been conducted primarily on small fur-bearing animals, and under unusual test conditions. It is generally accepted that the modus of injury by microwaves is a hyperthermia produced by absorption of this form of energy by the body. Extreme caution must be exercised in attempting to extrapolate the results of small animal responses to heat to those of the human body. Small fur-bearing animals have a high coefficient of heat absorption, a small body surface, and a relatively poor heat regulating system. The human body by comparison has one of the best, and can adjust readily and maintain thermal homeostasis under severe stress conditions. Adequate physiological function can be maintained in environments of 240°F for 23 minutes if the humidity is low, and at least 1 subject has been exposed to a temperature of 400°F for a period of approximately 1 minute, without tissue injury.

Conditions of radar operation and testing vary from experimental conditions. Humans are generally exposed while in free air,

and rarely to a stationary energized beam. Some radar beams are extremely narrow, and only a small portion of the human body is instantaneously exposed. The body can dissipate heat readily to the environment between such exposures. One is reminded of a similar problem associated with exposure of personnel to the thermal effects of ultrasonic energy. In an analogous situation, small fur-bearing animals were destroyed by hyperthermia when placed in a jet engine noise field, yet there is no evidence of any adverse heating effects upon man when exposed to the same environment. It has been estimated that it would require many million times the ultrasonic energy of that generated by any current jet engine to produce these effects in humans.

There is reason to believe that the dramatic effects observed in small animals exposed to whole body radiation will not be reproduced in larger, live animals under identical test conditions, and that the human body will be the most resistant of all. This is not to imply that localized application of heat cannot injure human tissue. We have witnessed one case of accidental 15-second exposure at a 6 to 10 inch distance, to an 'X' band radar of over 100,000 watts peak power output, with resultant erythema and a sensation of warmth for an hour, but with full and uneventful recovery. Unless carefully controlled and operated, microwave diathermy using 'S' band frequencies can cause local tissue damage.

In our study we have failed to detect any acute, transient or cumulative physiological or pathological changes in subjects working with and frequently exposed to high power radar transmitters.



It would therefore appear extremely unlikely that there exists a biological hazard to the radar technician observing reasonable precautions, or that the general public, exposed to greatly attenuated and intermittent doses of microwaves in the environment is in any danger of body injury. We can see no causal relationship between microwave exposure and any increase in such conditions as coronary heart disease, leukemia, bone and lung cancer and degenerative diseases of the nervous system.

There is need for additional research to explore the effects upon living tissue of extended wave lengths and frequencies of microwaves and transmitters of higher energy, and military research is being directed in this area\*. Colonel Knauf is to report on the progress of this research during this Association Meeting. It is hoped this study will provide the basis for establishment of a realistic safety program acceptable to all scientists.

Finally, a plea is made for deductive rather than inductive research in this difficult field. With the increasing exposure to microwaves in and around the home as well as in industry, careless and scientifically uncorroborated reports of human injury and death cannot avoid receiving dramatic and widespread dissemination. Such reports should not appear unless sufficient scientific data are included to support the conclusions and unequivocally establish the modus of injury. If radar is incriminated, the report must

---

\*Knauf, G. M., "The Biological Effects of Microwave Radiation on Air Force Personnel," AMA Archives of Ind. Health, Vol. 17, No. 1, January 1958.

7

contain a definite history of exposure, including proper identification of the transmitter, wave length, power density, exposure time, symptomatology, laboratory data, pathological findings, et cetera.

#### SUMMARY

In 1954 a medical surveillance program was instituted, covering 335 employees working with or exposed to microwaves in an airframe manufacturing company. Examinations have been performed at intervals of 6, 12 and 24 months, in an effort to detect acute or cumulative biological effects of exposure at various intervals to energized radar beams in the 400 to 9000 megacycle range, and with peak power output exceeding 1 megawatt. Whenever possible, identical examinations were also accomplished on a non-exposed control group.

The examinations have failed to detect any significant changes in the physical inventories of the subjects. The incidence of death and chronic disease, sick leave and subjective complaints was comparable in both groups.

A high percentage of eye pathology was identified, but none with causal relation to the hyperthermia produced by microwave absorption. Fertility studies revealed essentially the same findings for both groups.

Laboratory studies for total red and white blood counts and differential cellular studies revealed no significant changes above those noted in the control group. Urinalyses and chest x-rays

were noncontributory with respect to radar exposure. Electrophoretic serum protein determinations were performed on 26 subjects, with insignificant or accountable deviations in 10.

Platelet counts and controlled Rumpel-Leede capillary fragility studies revealed the fallacy of using either to identify radar exposure. In addition, only a small percentage of the exposed subjects had been aware of heat or other subjective warning phenomena. Neither these tests nor subjective complaints were considered reliable indices of exposure.

Absolute or safe maximum exposure standards were impossible to define, inasmuch as no radar-induced pathology could be identified. Subjects had been exposed for various periods, at indefinite distances, to a multitude of radars under flexible test conditions. The need for more precise and refined exposure data is indicated.

On the basis of these studies there appears to be no justification for public concern about the effects of greatly attenuated microwave energy in the environment. It would seem, therefore, one may continue to enjoy his television without undue apprehension.

RECOMMENDED TOLERANCE LEVELS OF M-W ENERGY

CURRENT VIEWS OF THE GENERAL ELECTRIC  
COMPANY'S HEALTH & HYGIENE SERVICE

by

B. L. Vosburgh, M. D., Consultant Health  
Services, General Electric Company,  
Schenectady, New York

COLONEL KNAUF:

It seems as though from the very beginning of our effort here at Rome we have been placed in a position where we appeared to be out of step in our safety criteria with the General Electric Company.

I assure you that not only have we not had any real differences, but in truth have been able to work together in a delightfully harmonious manner.

It is amusing at times how storms can start and then grow. A few weeks ago at a meeting at the RCA plant in Moorestown I was told that G. E. was unwilling to accept our proposed safe exposure level. This seemed strange for I felt we were in agreement. I planned to call Dr. Vosburgh at G. E. on my return to get the story straight and try to resolve any differences that existed. Before I could make that call Dr. Vosburgh called me and said he had been informed that we were abandoning our  $.01 \text{ w/cm}^2$  level for a more conservative one. I think we were both reassured on the position of the other at the end of that conversation.

As I contemplated this conference it seemed to me that it would be most desirable to have Dr. Vosburgh present his views to this group so that everyone would know that in the main we agree even though there may be minor differences perhaps of philosophy.

It is indeed a pleasure to introduce Dr. Beverly Vosburgh of the General Electric Company.

DR. VOSBURGH:

On June 1, 1954, the following safety measures relating to microwave radiation within the range from 1 - 40 cm. wave length were proposed at a meeting of General Electric engineers, safety specialists and doctors:-

- 1) Prevent exposure to a direct beam, especially of the eyes.
- 2) Appropriate procedures shall be applied to limit the direct or reflected intensity to 0.001 watt/square cm average in all locations to which people require access: (a) by the use of shielding or absorbing material, or (b) by remote viewing.
- 3) Authorized persons only shall have access to areas in which the level of the radiation intensity is close to 0.001 watt/square cm average, and they shall be subject to medical examination on the following basis by arrangement with the Works Physician: (a) Pre-employment vision test and exit vision test; (b) Spot check of those who have had radiation exposure; and (c) Check after any unusual exposure.

Attention is also called to the possibility of bodily heating from exposure to high-intensity radiation at wave lengths outside the 1 - 40 cm zone. While little quantitative information appears to be available, caution is recommended in all work with sources of high-frequency radiation to avoid exposure to high intensities, especially when the radiation causes fever or the feeling of heat locally. Obviously this restriction does not apply to treatment by high-frequency induction heating equipment under medical direction.

Several months later at a symposium held at the Mayo Clinic we had occasion to comment that our recommended safety factor of 100 in reference to eye exposure might appear excessive. However, we felt quite certain, since everyone was quite agreeable to that figure, that eye exposures to microwaves could largely be prevented.

Our recommended safety measures seemed realistic and so far as I know have imposed a hardship in only one instance.

We then added, "Speaking for the health and safety interests of industry, we regard this meeting as an opportunity to acquire a better perspective of the microwave hazard. It is reasonable to err on the safe side but not so far that it hurts; not so far that progress in the art becomes jeopardized; not so far that we will one day laugh too loudly at our present day fears."

Present day fears tend to increase because of much greater power outputs and a vision of fantastic amounts of power to come. In these high power developments I am told that many monitoring difficulties are being encountered. These difficulties may lead to precautions patterned after present day regulations for limiting exposure to ionizing sources.

You will be interested in what Harry Meahl, High Frequency Measurements Engineer, General Electric Company has to say about the many related problems of instrumentation and measurements as they relate to health and safety.

#### Impact of Increasing Power Output

It has been our experience that holding field strength down to the order of 10 watts per square meter in factory test areas was not difficult for radar transmitters having peak power outputs of tens of kilowatts and average power outputs of tens of watts. However, it became quite difficult to maintain this level for radar transmitters approaching peak power outputs of megawatts and average power outputs of kilowatts. In fact, usually certain areas had to be vacated while the transmitter was being operated because extra-

ordinary measures would have to be taken to reduce the field strength in those particular areas to the 10 watts per sq. m. level.

It has also been found that one has no more success with using a single instrument and making a single measurement to determine the field strength in an area than he would in prescribing a specific for the common cold. The reason is that the electromagnetic field is neither single frequency nor steady in amplitude. It may be the result of several frequencies, harmonics of the desired frequency or spurious frequencies, and many reflections of each so that the resultant pattern of field strength in space is like the light patterns seen on a lake when the wind blows.

A thorough survey of any radar or other high frequency test or operating site for safety purposes consists of making many measurements using indicated instruments which operate on different physical principles, each with different types of antennas and analyzing the results. For example, one instrument would respond approximately as well to many frequencies while another would be selective and respond practically to a single frequency. When more than one frequency is being emitted, the "broad-band" instrument should show a higher field strength than one which responded to any single frequency present.

As power outputs continue to increase, we may expect it to be necessary to devise new instruments for monitoring field strength because greater overloads become more probable and with them the probability of failure in the indicator.

In his paper\* "The Biological Effects of Microwave Radiation on Air Force Personnel" Colonel Knauf pointed out that today we have three exposure levels which are sponsored by three of the larger producers or users of this form of energy and which are widely separated. "It is immediately apparent that all three cannot be right", the Colonel emphasized.

From the comments furnished by our Mr. Meahl one might easily conclude, in accepting the value of 0.01 watts/sq. cm., and I might add parenthetically that the health and hygiene service of the General Electric Company does recommend that the General Electric Company strike an agreement with the armed services on this value, that we should anticipate that it will become necessary generally to monitor at a 0.001 mean watt value in order to make the necessary allowance for harmonics and spurious waves and then conclude with the net recommended ceiling tolerance level of 0.01 watts/sq. cm.

Even 0.001 watts/sq. cm. provides quite a bit of total body energy exposure when one considers that the average body surface of 2 meters would absorb approximately 10 watts.

So long as that 10 watts is considered to be in the form of thermal, noncumulative energy the chances are excellent that none of the bodies' tissues will light up or burn out, so to speak. But, if and when it has been proved that some important part of that energy is absorbed by susceptible tissues in the form of non-thermal energy having a cumulative effect, then, depending on the kind and degree of the damaging effects of such cumulative energy,

---

\*AMA Archives of Ind. Health, Vol. 17, Jan. 1958



we would quite naturally have to introduce whatever factors of safety that might be appropriate.

Pending the complete elucidation of the exact nature and biological effects of current and future electromagnetic energies, it might be expedient to undertake biological monitoring by introducing susceptible animals in representative environments where humans may have to be exposed. Such animals can be sacrificed at regular intervals in order to make certain that no damage is developing in such tissues as the lens of the eye, the testicle, the kidney and the brain.

We have in fact recommended such biological monitoring in certain areas of our own industry but I believe this recommendation has not yet been followed.

Before concluding it might be well to reflect on the low morale that might prevail among those having potential microwave exposures if, for example, workers came to believe, rightly or wrongly, that permanent testicular damage could or would result.

It seems doubtful that serious nonthermal cumulative tissue damaging effects are going to be demonstrated at the energy levels recommended for permissible exposure.

Present day instrumentation and screening techniques certainly can protect against thermal tissue effects.

Before grandiose electromagnetic energies may come to introduce important nonthermal, cumulative damaging effects on specialized tissues, we hope that we will have gained sufficient experience and knowledge to apply the necessary additional factors of safety.

## REVIEW OF THE BIOLOGICAL EFFECTS PROGRAM

by

George M. Knauf, Col., USAF(MC)  
Rome Air Development Center

We come now to the portion of the program for which I am sure you have all been waiting. We will hear from each of the research groups a resume of the work they have accomplished to date in their assigned investigative areas. Some of these folks have only recently gotten their work under way. All of them, however, are dedicated people and I feel sure will impress you with the effort they are putting into their work. I should like to say publicly that being permitted to associate with and work with this outstanding group is the finest thing that has happened to me in my military career. It should be said also for the record that much of the delay in getting some of these programs started rests squarely on my shoulders. In some instances I had difficulty obtaining required equipment, while in other instances delays were born of administrative tangles. I think all of this is now behind us and all of the work is proceeding at a gratifying pace.

I am not going to attempt to tell you a great deal about any one of these individuals, but will instead try to outline the area of responsibility peculiar to each group. As you know we selected five different representative frequencies, 200, 3000, 10,000, 24,500, and 35,000 megacycles. The first four of these were assigned to the University of Buffalo, The University of Rochester, University of California, and the University of Miami. The last, 35,000 megacycles, has not been initiated because we have not to date been

able to locate equipment producing a biologically significant level of power. In addition to these representative frequencies we have initiated investigations of microwave effects on the eye, on the brain, and on hollow viscera. These efforts will be reported upon by the Tufts University, The University of Pennsylvania, and the State University of Iowa. Our friends in the Navy have sponsored similar research efforts at Tulane University and The University of St. Louis, which will be reviewed by representatives of those groups. In conclusion the Southwest Research Institute will discuss the work they are doing for us in exploring the value of electron paramagnetic resonance and nuclear magnetic resonance techniques in the over-all bio-effects program.

SURVEY OF MICROWAVE ABSORPTION CHARACTERISTICS  
OF BODY-TISSUES

by

Herman P. Schwan, Ph. D., University of Pennsylvania

I will summarize absorption data pertaining to body tissues and mostly obtained in our laboratory during the past six years. Some of the data have been presented before, and some of you may recognize part of them. Other data has been shown only before a small group and finally, some important data not shown as yet which are of very recent origin. I intend to demonstrate this material in toto for the following purposes. First, it will show the variability of absorption characteristics between various types of tissues. Second, we will show the variability of absorption values from sample to sample in a given type of tissue and determine its reasons. Third, from the now available total knowledge of absorption characteristics of all major types of tissues, we can confirm our earlier statement that frequencies above 10,000 megacycles are not as dangerous while frequencies below 1,000 megacycles establish by comparison a major hazard. Fourth, from the complex absorption characteristics we are able to state that it will be in principle impossible to develop any type of dose meter which can be carried on or near the human body and give sensible readings.

The first group of figures will relate to a survey of dielectric data; the second, to a survey of absorption coefficients; and the third, to reflectance and energy distribution patterns.

We present in Figure 1 data to illustrate drastic differences between the dielectric properties of tissues with high and low water content. The capacitance is plotted in terms of dielectric constants for muscular tissue and fat within the frequency range of about 40 to 10,000 megacycles. The upper curve pertains to muscular tissue and is representative of most body organs. The lower curve relates to fat and subcutaneous fatty material and is also characteristic of other tissues of low water content. The variation from one sample of muscle tissue to another is within about 10 per cent; i.e., the dielectric constant of muscular tissue and body organs varies only slightly so that it is reasonably easy to reproduce these data.

The specific resistance is plotted on the ordinate and the frequency on the abscissa within the frequency range of 40 to 10,000 megacycles (Figure 2). The resistivity data for muscular tissue are reproducible over the entire frequency range while the fat data fluctuate considerably as indicated by the broad band extending nearly across the graph. This indicates that the resistivity of fatty material cannot be readily duplicated and that the variability from one sample of fatty material to another is considerable.

In Figure 3 the conductivity versus the dielectric constant of fat (human autopsy material) is plotted. All data pertain to 900 megacycles, but at other frequencies similar curves could be demonstrated. The graph explains that the conductivity of all normal samples shown here varies by a factor of five. Two samples, with a conductivity near  $4 \text{ m Mho/cm}$ , pertain to tissues of abnormally

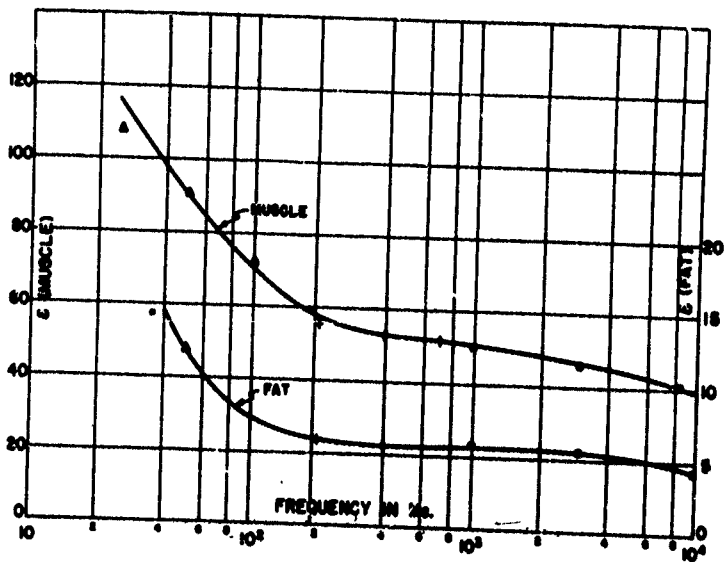

Figure 1

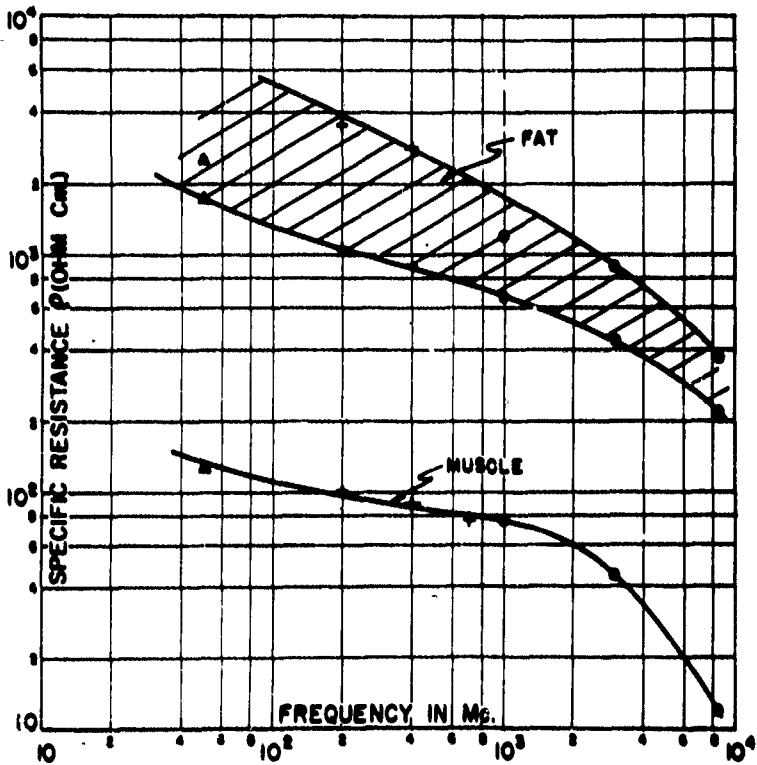

Figure 2

high electrolyte content, related particularly to the cause of death. One sample, indicated by the arrow, was measured after dehydration in the oven. It should be noted that the dielectric constant varies by a considerably smaller range. This illustrates why, by comparison, good reproducibility of dielectric constant and a poor one of conductivity result. On the other hand, there is a systematic relationship between the conductivity and the dielectric constant data. The reasons for this behavior become apparent in the next figure.

In Figure 4 the dielectric constant of fatty tissue versus percentage of water contained in fat is plotted at 300 megacycles. Water determinations were carried out in the routine manner. Observe the well-defined relationship between the dielectric constant and the water content of fatty tissue. With increasing water content, the dielectric constant rises. This is anticipated since water has a high dielectric constant. The arrow between the two and four mark indicates the value resulting from dehydration of fat.

The conductivity of fatty material versus the percentage of water contained in fat is plotted at 300 megacycles (Figure 5). Even though somewhat more fluctuation occurs than in the previous figure, a clearly defined relationship is apparent. Again, increasing the water content increases the conductivity. It is noteworthy that the variation in water content is within the normal range through the major part of the curve. Two abnormal cases of high water content are included in the figure to more clearly establish the relationship between conductivity and water content.



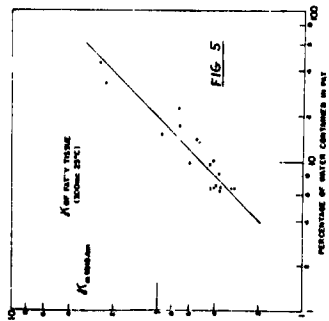
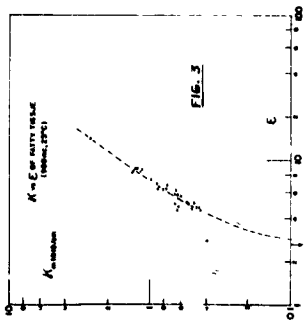
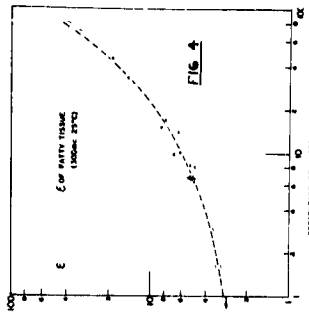

In summary of the above presented dielectric data:

1. Dielectric constant and conductivity of tissues of high and low water content are very different from each other.
2. Dielectric constant and conductivity of muscular and other tissues of high water content are well reproducible; i.e., variation from sample to sample is small.
3. Dielectric constant and conductivity of fatty tissues vary considerably from sample to sample. The variation is more pronounced for the conductivity than the dielectric constant. However, a uniform and reproducible relationship exists between (a) dielectric constant and conductivity at any given frequency, and (b) both dielectric constant and conductivity on the one hand and water content on the other. Hence variability of dielectric data of fatty tissues reflects a corresponding variability in water content.

The above formulated conclusions are justified for the total frequency range of interest for radar purposes. They have been secured for the spectrum from 40 to 10,000 mc.

Figure 6 presents selected material and condensation of conductivity values from all the material we have measured. The vitreous humor, yellow bone marrow and bone (the points around yellow bone marrow pertain to bone per se) indicate the extremes of the total range of data, and all other data fall in between. The conductivity is almost constant up to 1,000 megacycles and then it increases very rapidly with frequency. Above 30,000 megacycles the conductivity approaches constant values again. With these electrical data and the dielectric constants presented in Figure 7,

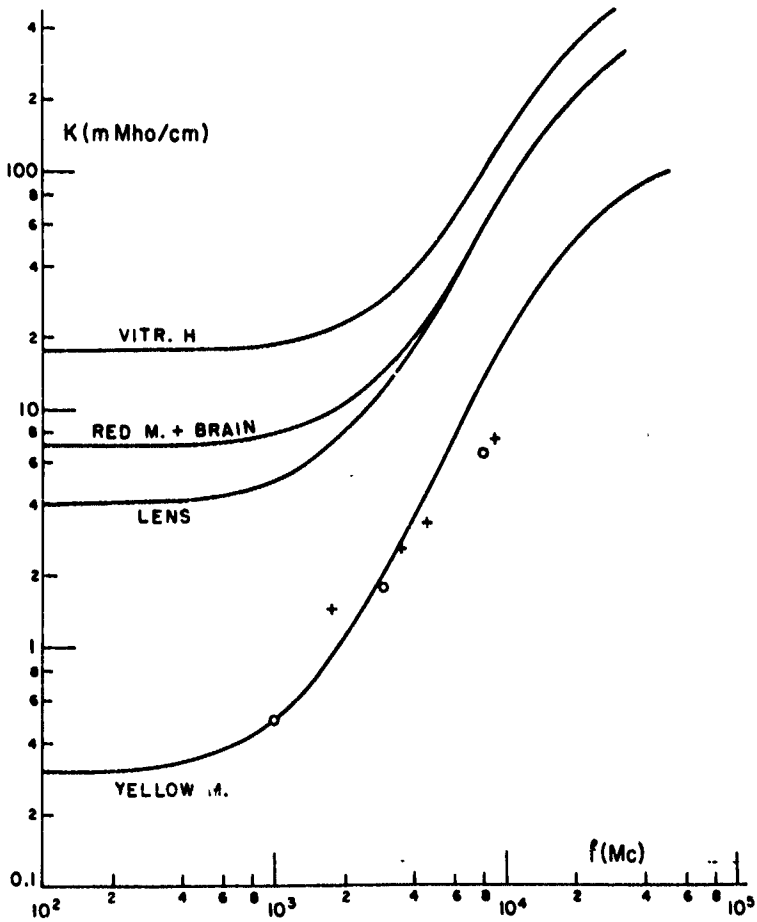

Figure 6

we have all the essentials available for the determination of absorption coefficients.

The same materials shown in the previous figure are repeated in Figure 7, but, in this case, they relate dielectric constant data. The vitreous humor and the yellow bone marrow still establish the extremes of range. All other materials tested, which are too numerous to include here, fall between these two extremes. The values below 1,000 megacycles are relatively constant. Above 10,000 megacycles, there is a pronounced decrease.

For the next series of figures we have translated the available dielectric data in absorption coefficients, or rather their inverse; i.e., depth of penetration values.

Figure 8 demonstrates the principal behavior of the penetration as function of wave length in air. The curve extending from the lower left hand corner (the infrared range) up to more than 1,000 centimeters pertains to muscular and similar tissue. This curve demonstrates two principal regions. One region pertains to a small change at relatively long wave lengths and seems to approach a plateau between 10 and 100 cm. But before achieving the plateau, the penetration drops off abruptly and approaches finally in the infrared range another constant value. This data has been extrapolated with a pertinent theory and corresponds nearly identically with infrared experiments conducted by physiologists. While this frequency over a more limited range is the principal behavior, Figure 9 presents more detailed data.

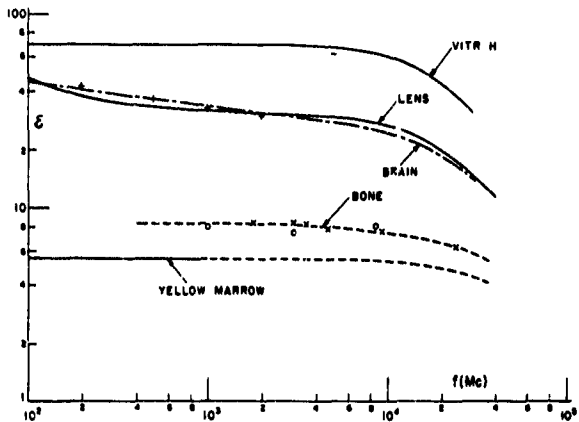

Fig. 7

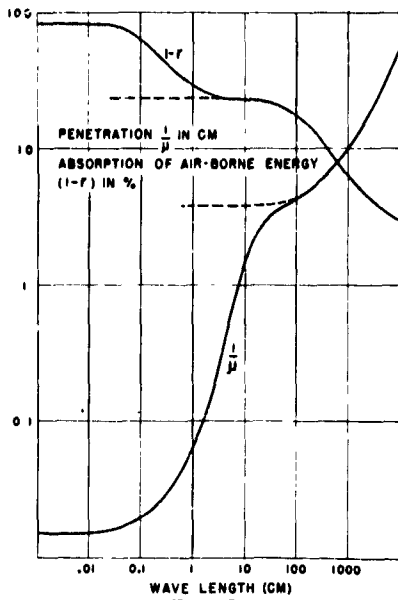

Fig. 8

Depth of penetration of fatty tissue and tissues with a high water content such as muscle are plotted in Figure 9 for various frequencies. The range of variability for fatty tissue, which does not appear on the graph, is higher and lower than the average curve by a factor of approximately 1.5. These curves are restricted to the immediate range of interest; i.e., from 100 megacycles to 10,000 megacycles. Observe that at frequencies below 1,000 megacycles the depth of penetration changes relatively little. Above 1,000 megacycles, the depth of penetration decreases very rapidly.

Figure 10 gives penetration values for different frequencies and compares brain tissue and red bone marrow with muscle. Note that the depth of penetration at 3,000 megacycles is approximately eight or nine millimeters and then falls off rapidly. At 30,000 megacycles penetration reaches a depth of only 0.3 millimeter.

The depth of penetration values apply in Figure 11 to yellow marrow and bone. At 3,000 megacycles the depth of penetration is about five centimeters. In other words, the ability to penetrate yellow marrow and bone is about tenfold or one order of magnitude higher than it is to penetrate muscle and red marrow.

In Figure 12 the depth of penetration is plotted over a very wide frequency range for the vitreous humor and lens of the eye. Note that both curves approximate a plateau around 1,000 megacycles. The lens material behavior at very high frequencies is almost identical to that of the vitreous humor. At lower levels, however, the lens curve is somewhat higher reflecting its higher protein content and consequent lower conductance.

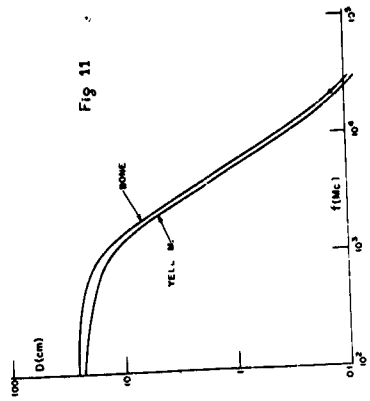
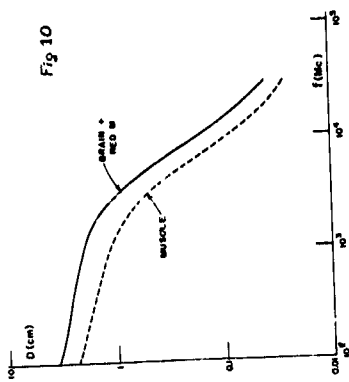
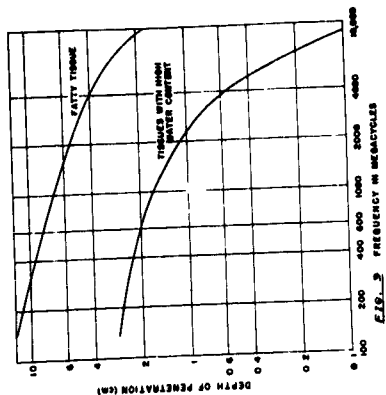

Fig 11

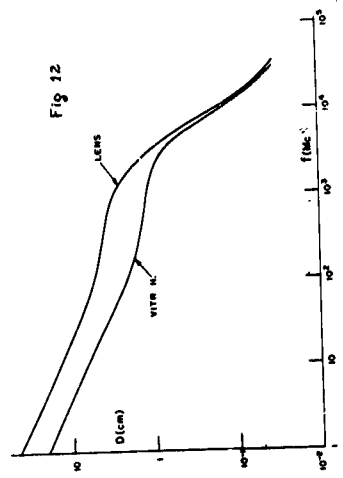

Fig 12

In discussing both the depth of penetration of the radiation and the resultant penetration of heat, thermal conductance and radiation must both be born in mind as the two factors of importance. For example, when depth of penetration of radiation is great, then it might be anticipated for physical reasons that thermal conduction would be small in its influence on the effective penetration of heat. The opposite holds when the absorption coefficient is very high, i.e., depth of penetration is very low. This is demonstrated by three heating curves which Cook presented for wavelengths at 10, 6.5, and 1.25 centimeter (Figure 13). The curves resulting for 1.25 and 6.5 cm are essentially identical; even so, depth of penetration values are greatly different. In essence, this means that a radiation frequency substantially higher than 3,000 megacycles merely acts as a surface heating device similar to infrared, and that heat penetration must rely on conduction.

A few summarizing comments about the presented absorption values seem in order:

1. Depth of penetration in muscular and similar tissues is about tenfold larger than in fatty and similar tissues. A complete survey of absorption characteristics reveals, however, that there are some tissues such as brain, which places itself in between.
2. Depth of penetration decreases with increasing frequency, slowly below 1,000 mc and increasingly rapid above.
3. Depth of penetration in the majority of tissues with relatively high water content decreases below 1 cm as the frequency



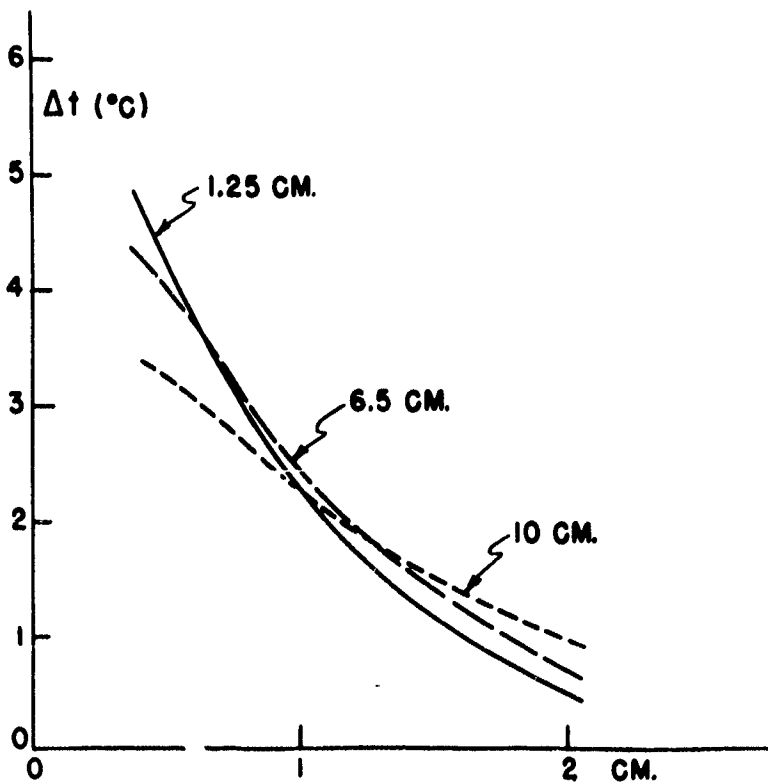

Figure 13

reaches above 3,000 mc. Its ability to deliver heat inside the body relies to an increasing extent on heat conduction instead of "primary" production. It therefore becomes from a practical point of view comparable with infrared in its effects on mankind.

For experimental work some suggestions result from the data:

a) As radiation frequency increases and penetration decreases, the likelihood to internal damage decreases; i.e., higher frequencies are less damaging than lower ones. This statement, of course, is only valid if the total penetrated energy is absorbed; i.e., if penetration values are small compared to physical dimensions of the test animal. The presented penetration values show that this is always true for mankind.

b) If experiments are carried out with animals of a physical size which is comparable or less than above reported penetration values, only part of the available energy flux will be consumed. As a result, any anticipated simple relationship between damage and radiation flux will be distorted. For example, it will be virtually impossible to generate substantial temperature elevation in mice at 100 or 200 mc. However, the same frequency must produce substantial internal heating in mankind if applied with the same flux. The consequences for experimental work seem evident.

The third and last section of figures refers to data of reflectance and energy distribution.

In Figure 14 the percentage of absorbed energy is plotted as a function of frequency for muscular tissue alone. The plateau in the 1,000 megacycle frequency range represents a value of approximately 40 per cent absorbed energy. Note the increase in absorbed energy as frequency increases beyond 10,000 mc.

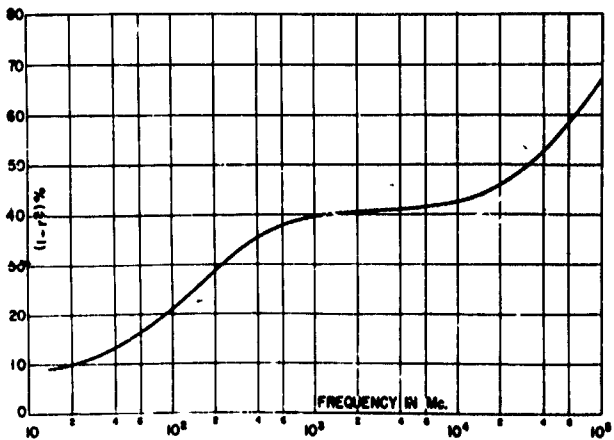

Figure 14

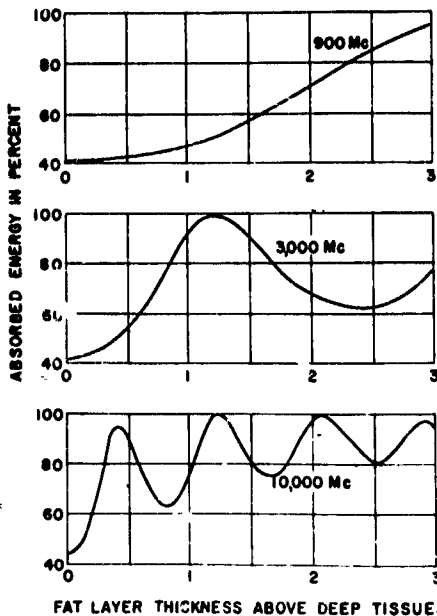

Figure 15

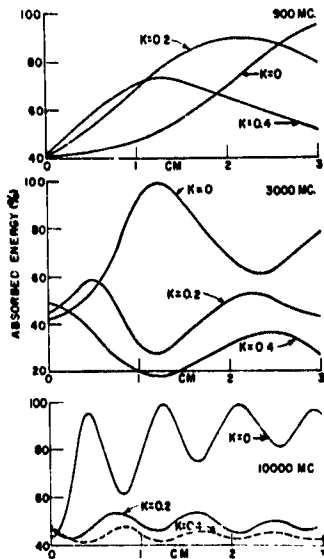

Figure 16

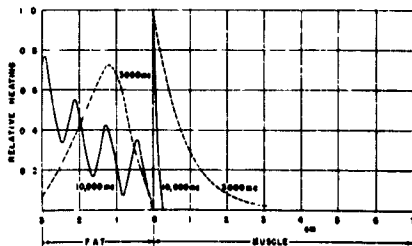
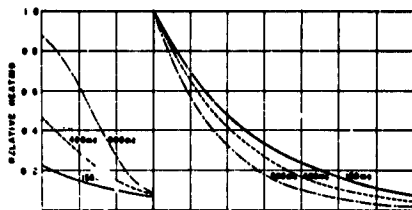

Figure 17

In the presence of other tissues the situation becomes more complex (Figure 15). For example, the amount of absorbed energy varies with the thickness of the subcutaneous fatty layer. The variation is relatively slow at lower frequencies. As the frequencies increase, however, the amount of absorption becomes more erratic, resulting in a more complex situation.

Figure 16 is presented only to illustrate the extreme variability in absorbed energy when three tissues are considered together. The curves superimposed on one another represent the absorbed energy of skin, subcutaneous fat and deep tissues. This is a realistic relationship which would occur in the body. Note that the total amount of absorbed energy can vary between 20 and 100 per cent; i.e., by a factor of five.  $\underline{x}$  denotes the skin thickness in cm; the abscissa indicates the thickness of the subcutaneous fat layer.

The situation in Figure 17 is somewhat idealized as only fat and muscle are considered. The inclusion of skin would further complicate matters. Observe that at the interface between fat and muscle the relative heating is much lower in fat than in muscle. This merely indicates that the impedance of fatty material and muscular tissue is very different. The consequent large reflection of energy into fatty material results in a reduction of the field strength at the boundary (fat-muscle), and a correspondingly smaller heat development there. Under proper conditions an appreciative reduction in field strength near the body may obtain, while a large energy absorption may take place within the body

itself. Thus, in principle, it appears impossible to construct a dosimeter which measures reproducibly absorbed energy and can be carried on or near the human body. In our opinion measurements should be taken in the "distant field" to enable standardization of experiments.

#### SUMMARY

Now permit me to summarize and draw some conclusions from the above presented material.

a) The reviewed absorption data cover a total range of about 1 to 10  $\mu$  at any particular frequency. Extremes are provided by the glass body of the eye and yellow marrow and dry fat. In between we find an almost continuous assembly of data.

b) The determination of absorption characteristics is a prerequisite to much experimental work. For example, in order to determine the dose to which animals much smaller than the depth of penetration or cellular organism are exposed, absorption coefficients are a prerequisite. Without their knowledge no quantitative statements are possible.

c) For most tissues frequencies substantially higher than 3,000 mc cause mere surface heating; i.e., act like infrared or sunlight. At lower frequencies, particularly below 1,000 mc, much larger penetration is achieved. This statement is valid for all tissues.

d) From the complexity of reflectance and energy distribution it is concluded that no dose meter can be constructed which can be

carried on or near the body surface and give sensible data. On the contrary, its readings may be by far too low due to cancellation of field strength as a consequence of standing wave patterns.

e) Standing wave pattern in the body makes it senseless to talk about energy flux in the body and to use it as a measure of dosage. All dose or dose rate statements must refer to field or flux values in the distant field defined sufficiently far from the body to be affected by its presence.

REVIEW OF THE WORK CONDUCTED AT TUFTS UNIVERSITY  
Experimental Radiation Cataracts Induced by Microwave Radiation

by

Russell L. Carpenter, Ph. D.  
Department of Biology, Tufts University

Our work at Tufts has been aimed chiefly, but not exclusively, at studying the effect upon the eye of microwave radiation at a frequency of 2450 megacycles and wave length of 12.3 cm. Engaged in this effort, in addition to myself, are Mr. David Biddle and Dr. Hal Freeman, both of whom are present at this conference, and Mrs. Claire Van Ummersen. We also had as a member of our group last year Dr. Cayetano Mangahas.

Before reporting on our work on the eye, I wish first to summarize briefly the results to date of a study of the effects of this frequency on the developing chick embryo. This work has been done chiefly by Mrs. Van Ummersen, who has incubated eggs for 48 hours, exposed them to microwave radiation for periods of 6 to 9 minutes at a power density of 0.28 watts per square centimeter, and then returned them to the incubator for another 48 hours. Nine minute exposures were lethal and exposures of 6 minutes had no apparent effect, but exposures of 7 or 8 minutes duration resulted in numerous developmental abnormalities which were evident when the embryos were examined at the 96 hour stage. In general, it can be stated that microwave energy of this frequency causes supression of further differentiation but not of proliferation in organs which have already been established by the 48 hour



stage, such as the brain, eye and heart. For example, the brain at 48 hours normally has three vesicles but by 96 hours the prosencephalon and the rhombencephalon have each become divided, so that there is a total of five vesicles. When exposed to microwave radiation at the 48 hour stage, the brain subsequently continues to grow but remains in the three vesicle condition. Likewise, the heart continues to increase in size but does not undergo normal differentiation. It appears also that the effect upon regions of the embryo which have not been established by the 48-hour stage is to inhibit their development. In most cases, the posterior appendage bud and the tail bud fail to develop; in all cases, development of the allantois is inhibited.

This work is still in progress, with study of the serially sectioned embryos being made and attention being given to the question of whether there is any difference in mitotic activity in the irradiated embryos as compared to normal control embryos.

#### LENS OPACITIES RESULTING FROM MICROWAVE RADIATION

The cataractogenic effect of microwave radiation has been previously established by the work of Richardson, Duane and Hines; Williams, Monahan, Nicholson and Aldrich; Daily, Wakim, Herrick, Parkhill and Benedict; and others. For the past two years, we have been studying in some detail the conditions under which lenticular opacities are produced by microwave energy at 2450 Mc. Our first task was to establish in terms of time and power the thresholds for cataractogenic exposures and to study the

accompanying thermal changes. Following this, we investigated the cumulative effects of repeated subthreshold exposures to microwave radiation. Inasmuch as continuous wave radiation was employed in both of these series of experiments, we undertook to discover whether pulsed microwave radiation of the same average power density would have similar effects. I shall report today on these three aspects of our work.

#### Time and Power Thresholds.

Our microwave source was the Raytheon Microtherm Model CDM4. Male New Zealand white rabbits, 6 to 10 weeks old, were anesthetized by sodium Nembutal administered intravenously and exposed with the right eye at a measured distance of two inches from the plastic housing over the dipole crossover of the Microtherm director "C." Following exposure, ophthalmoscopic and slit lamp examinations of the eye were made daily and notes made of any changes. When advisable, stereo color photographs of the eye were taken with a Donaldson stereo ophthalmic camera at initial magnifications of 2 or 2½ times. This could be done without anesthesia and gave excellent detailed photographs of the progress of lenticular opacities over considerable periods of time. Many of the slides with which this presentation will be illustrated are single pictures taken from such stereo pairs.

The results of 56 experiments are shown in Figure 1, in which the microwave energy, expressed both as applied power density in watts per square centimeter and as the percentage of output of the Microtherm, is plotted against time. Solid circles represent

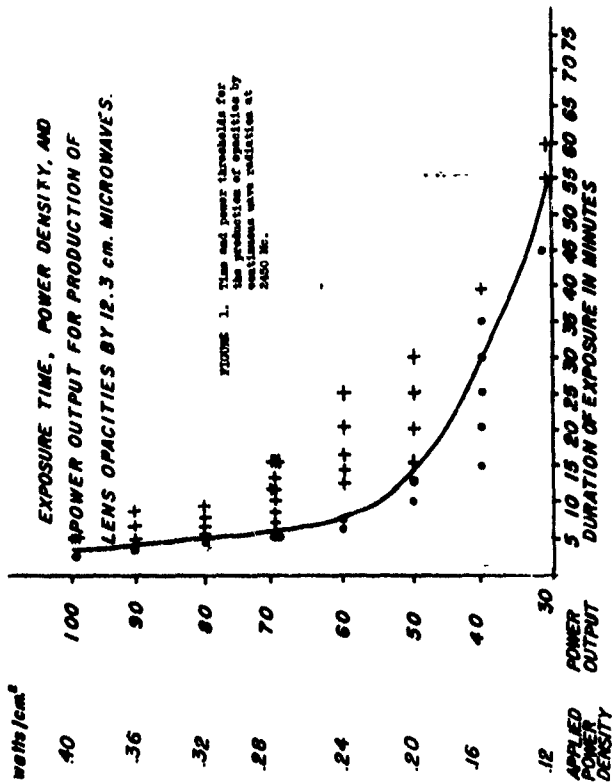

negative results; crosses represent opacities. It is evident that the higher the power, the less the duration of a single exposure required to produce an opacity. Conversely, as the power is decreased, the duration of exposure must be increased if an opacity is to result from a single exposure. If the threshold curve shown in Figure 1 be plotted logarithmically, we find that the power multiplied by the square root of the time is a constant.

Our measurements of the power density of the R-F field at the position of the eye were made by a calorimetric method. A hollow sphere the size of a rabbit eye was constructed of a plastic of low dielectric constant. It was placed in the microwave beam at the two inch distance employed in the experiments and filled with saline solution into which was inserted the 22 gauge hypodermic needle thermistor probe of a thermistor-thermometer circuit. It was thus possible to obtain a continuous direct reading of the temperature rise in the sphere during microwave irradiation over a given time. Heating and cooling curves were recorded and from this data and the known volume and cross-sectional area of the sphere, the amount of energy absorbed could be calculated. We arrived at a figure of  $0.42 \text{ w/cm.}^2$  as the power density of our microwave beam at this distance.

We were encouraged as to the validity of this estimate by the fact that measurements made at the Rome Air Development Center on the same model of Microtherm, but by a method employing a matched horn antenna and power meter, gave a figure of  $0.40 \text{ w/cm.}^2$ . Because of the close agreement, we have therefore taken the figure of  $0.40 \text{ w/cm.}^2$

as the power density in our experiments at the maximum output of our generator.

It may be of some interest to summarize certain of our observations with regard to the onset of lenticular opacities and their further progress. The latent period between the time of exposure and the time of appearance of a recognizable opacity varies from 1 to 6 days, the average time being  $3\frac{1}{2}$  days. The early changes in the lens can be recognized by slit lamp but not by ophthalmoscopic examination. The first visible sign of change is in the posterior subcapsular cortex; it appears as concentric lamellae of greater optical density separated by clear zones. There may be from one to three such bands parallel to the posterior capsule. We have referred to this as posterior cortical banding. In minimal exposures, it may clear up within a few days with no opacity being formed. In all cases in which opacities occur, however, they are characteristically preceded by the cortical banding. Subsequently, there may occur thickening and increased density of the posterior suture, formation of small vacuoles or granules above and below the suture line, or clusters of small vesicles at each end of the suture. In a number of cases, fiber-like processes appear at the ends of the suture line and progress axially to form flat bows or arcades above and below the suture, after which the axial area which they enclose becomes more or less filled in by irregular fibrous and filamentous processes to give a cottony appearance to the lens cortex. In all cases, these changes take place in the posterior subcapsular zone. With exposures of sufficient power or duration, strings of vesicles which are fairly large occur peripherally in

the posterior subcapsular region. The degree of opacification varies with the power and duration of the exposure, from a few granules, vacuoles or fibrous streaks in the region of the posterior suture line to frank circumscribed or diffuse opacities. Some of the minimal opacities may exhibit regression; more extensive lesions go on to become mature or even hypermature cataracts.

It can be stated that the absence of pigmentation in the eye of the New Zealand white rabbit is not a factor in the sensitivity of the lens to microwave radiation, for we obtained similar results when the New Zealand red rabbit, which has pigmented eyes, was used.

Some ocular reactions were noted immediately after irradiation -- and again they varied in degree with the power and duration of the exposure. They included hypermia of limbal and iris vessels, pupillary constriction, swelling and chemosis of palpebral and bulbar conjunctiva, and vitreous floaters and filaments. At power levels of  $0.28 \text{ w/cm}^2$  or less, these effects were transient and of minor severity, provided that the period of irradiation was not unduly long.

#### Temperature Changes in the Eye.

The thermal effects noted above suggested the advisability of studying temperature changes within the eye which accompany exposure to microwave radiation. Accordingly, the termistor needle probe was inserted in the eye with its tip positioned in the vitreous body directly behind the posterior pole of the lens but not in contact with the lens capsule. The temperature of the vitreous was recorded during irradiation at five different power levels:  $0.12 \text{ w/cm}^2$  (30% of

power); 0.20 w/cm<sup>2</sup> (50% of power); 0.28 w/cm<sup>2</sup> (70% of power); 0.36 w/cm<sup>2</sup> (90% of power); and 0.40 w/cm<sup>2</sup> (100% of power). The results are shown in Figure 2. It is apparent that as the power is increased, the temperature of the vitreous rises more rapidly and reaches a higher level before tending to flatten out. This is exactly what one should expect: the more energy applied per unit of time, the greater and more rapid the thermal effect from absorption of that energy.

In Figure 3, this information in chart form is related to the previously established time and power thresholds for production of lens opacities. The shaded squares represent for each power level the minimum duration of exposure which causes opacities to form. The significant fact which emerges is that at each power level, the threshold time for opacity formation coincides with the time of exposure at which the vitreous temperature closely approximates 50 degree Centigrade. The obvious conclusion to be drawn is that the cataractogenic effect of microwave radiation is a thermal effect, with 50 degrees Centigrade constituting a critical temperature. However, in the light of certain experiments to be reported subsequently, I ought at this time to sound the warning that there are occasions when the obvious conclusion may better be left undrawn!

Cumulative Effects of Repeated Subthreshold Exposures to Microwave Radiation.

Having established thresholds for opacity production by single exposures to continuous wave radiation, we sought to discover whether repeated subthreshold exposures might have some cumulative effect. We chose a power density of 0.28 w/cm<sup>2</sup>, at which level we had found

**VITREOUS TEMPERATURE AVERAGES:  
100% 90% 70% 50% 30% (20CASES)**

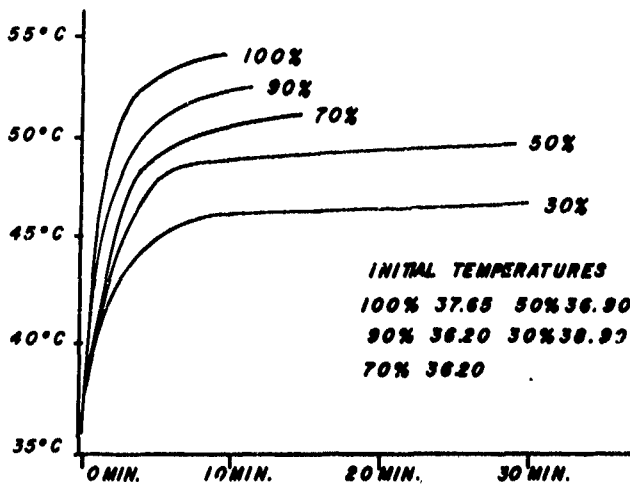

Figure 2. Temperature of vitreous body during exposure to continuous wave radiation at different power levels. (100% equals 0.40 w/cm.<sup>2</sup>; 90% equals 0.36 w/cm.<sup>2</sup>; 70% equals 0.28 w/cm.<sup>2</sup>; 50% equals 0.20 w/cm.<sup>2</sup>; 30% equals 0.12 w/cm.<sup>2</sup>)



Temperature of Vitreous During Exposure to Microwave Radiation. (20 cases)  
(12.3 cm; 8450 Megacycles)

Centigrade temperature at end of: Minutes

	0	1	2	3	4	5	6	7	8	10	15	20	30	40	50	55	60
0.40 -	37.7	44.6	48.5	50.8	52.1	52.5	53.4	53.7	54.2	54.3							
0.36 -	36.2	44.7	48.1	49.8	50.5	50.8	51.1	51.4	51.8	52.2							
0.32 -																	
0.28 -	36.0	42.9	45.5	47.2	48.5	49.3	49.4	49.8	50.0	50.3	51.0	51.3					
0.24 -																	
0.20 -	36.9	41.9	44.3	45.8	46.8	47.4	48.2	47.4	47.9	48.9	49.0	48.7	49.7				
0.16 -																	
0.12 -	38.0	41.0	42.6	43.6	44.5	45.0	45.4	45.8	46.0	46.1	46.2	46.6	47.2	48.1	49.4	49.5	50.3

Shaded squares represent minimum exposure times for production of opacities.

Figure 3. Vitreous temperatures and thresholds of exposure for production of lens opacities.

that 6 minutes was the minimal exposure period which would cause an opacity to develop. We therefore subjected 43 rabbits to repeated exposures each of 5 minutes, 4 minutes,  $3\frac{1}{2}$  minutes or 3 minutes duration, with intervals between exposures ranging from 24 hours to two weeks. Control experiments were given only a single irradiation.

Thirty-four of the 43 rabbits developed various degrees of lenticular opacities, ranging from small aggregates of granules, vesicles or fiber-like processes in the vicinity of the posterior suture line to extensive lesions involving a substantial part of the posterior subcapsular cortex. In 14 of these cases, partial or complete regression of the cataract occurred. On the other hand, in a number of cases the lesions have persisted for periods which up to now have reached 11 months.

Typical of this latter condition is the case illustrated in Figure 4. The eye was exposed twice for periods of 4 minutes each to a power density of  $0.28 \text{ w/cm}^2$ , the exposures being spaced two weeks apart. Five days after the second exposure (20th day of the experiment), the posterior suture line appeared granular and arcade fibers extended upward and downward from its nasal end. Two days later, small vesicles were evident at each end of the suture line and the axial region of the posterior subcapsular cortex showed granules and many irregular fibrous processes. On the 25th day, feathery striations appeared in the inferior peripheral posterior cortex, toward the lens equator, and the axial and paraxial region showed numerous granules and vesicles. By the 33rd day, the peripheral striations had disappeared and the opacity then exhibited its final

R-42 4 MIN. EOWx2

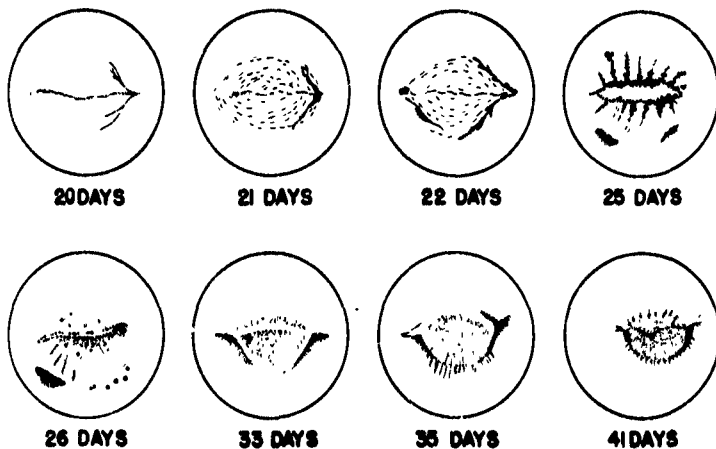

Figure 4. Stages in the development of a permanent lens opacity resulting from two 4 minute exposures, two weeks apart, to microwave radiation at a power density of  $0.26 \text{ w/cm}^2$ . Days are numbered from the initial exposure on the first day.

form, subject only to becoming more dense and compact.

Regressive changes are illustrated in Figure 5. In this case, the eye was exposed for 3 minutes each day for 5 days. The power density was  $0.28 \text{ w/cm}^2$ . On the eighth day, granules, vesicles and arcuate fibers were seen along and above the suture line in the posterior subcapsular region. On the 13th day, the posterior zone showed a striate and granular opacity which formed a peripheral collaret. By the following day, a striate opacity of similar nature had developed in the paraxial region and numerous vesicles extended along the line of the posterior suture. Despite the extensive opacification which occurred in this lens, regressive changes took place rapidly. Within 24 hours, the peripheral striate opacity had disappeared and in another day so also had the temporal half of the paraxial striations. A few days later and the entire lens was clear.

Conditions under which cumulative effects have been manifest are the following:

1. Five minute exposures.

- a. Five minute irradiation each day for a total of 4 or of 5 exposures.
- b. Five minute irradiation every other day for a total of 2 or of 3 exposures.
- c. Five minute irradiation each week for a total of 2 exposures.

The results of repeated 5 minute exposures are summarized in chart form in Figure 6, prepared by Dr. Freeman. The term "central

R 44 3MIN. E D 5



8 DAYS

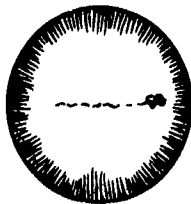

13 DAYS



14 DAYS



15 DAYS



16 DAYS

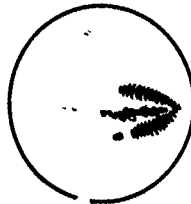

17 DAYS

Figure 5. Stages in the development and regression of a lens opacity resulting from five 3 minute daily exposures to x-ray radiation at a power density of  $0.28 \text{ w/cm}^2$ . Days are numbered from the initial exposure on the first day.

opacification" as there used refers to opacification of the axial region of the posterior subcapsular cortex. The symbol "X" indicates termination of the experiment; the arrowhead symbol denotes that the experiment was still in progress at the end of 12 weeks, when this chart was prepared. Each solid circle represents a single 5 minute exposure.

2. Four minute exposures.

- a. Four minute irradiation each day for a total of 4 or of 5 exposures.
- b. Four minute irradiation each week for a total of 2 or of 4 exposures.
- c. Four minute irradiation every other week for a total of 2, 3 or 4 exposures.

Results of repeated 4 minute exposures are summarized in Figure 7. Each solid circle represents a single 4 minute exposure.

3. Three minute exposures.

Exposures of  $3\frac{1}{2}$  or 3 minutes duration, made each day for 5 consecutive days, are summarized in Figure 8.

We have concluded from these experiments that opacities may develop as a cumulative effect when the eye is repeatedly exposed to amounts of microwave radiation which singly exert no harmful effect. The cataracts so produced do not differ significantly in morphology or in severity from those caused by single exposures which are above threshold values. There is some suggestion that the severity of the reaction may be related to the frequency

REPEATED SUBTHRESHOLD EXPOSURES  
AT 0.28 WATTS/CM<sup>2</sup> 5 MIN

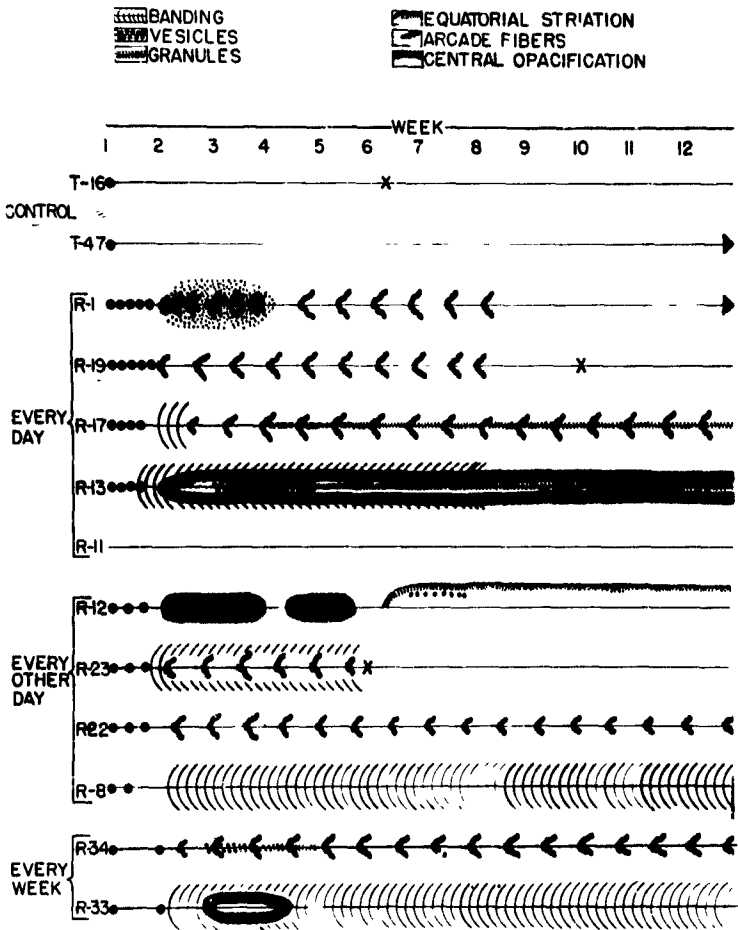

Figure 6. Effects of repeated subthreshold exposures of 5 minutes each at a power density of 0.28 w/cm.<sup>2</sup>. Each solid circle represents a single exposure.

REPEATED SUBTHRESHOLD EXPOSURES  
AT 0.28 WATTS/CM<sup>2</sup> 4 MIN

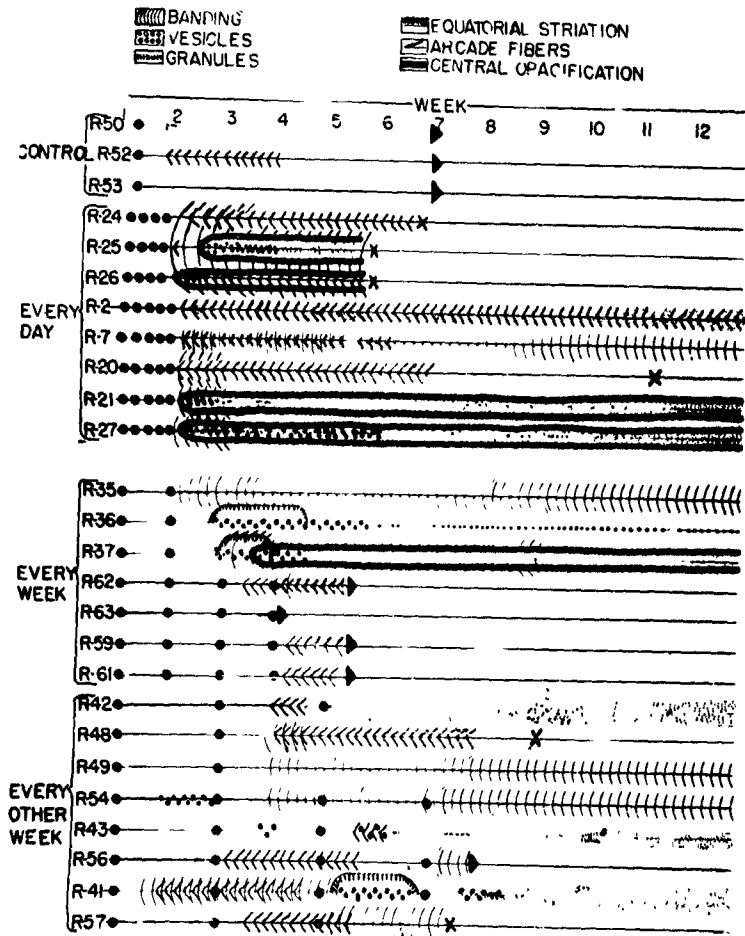

Figure 7. Effects of repeated subthreshold exposures of 4 minutes each at a power density of 0.28 w/cm.<sup>2</sup>. Each solid circle represents a single exposure.



REPEATED SUBTHRESHOLD EXPOSURES  
AT 0.28 WATTS/CM<sup>2</sup>

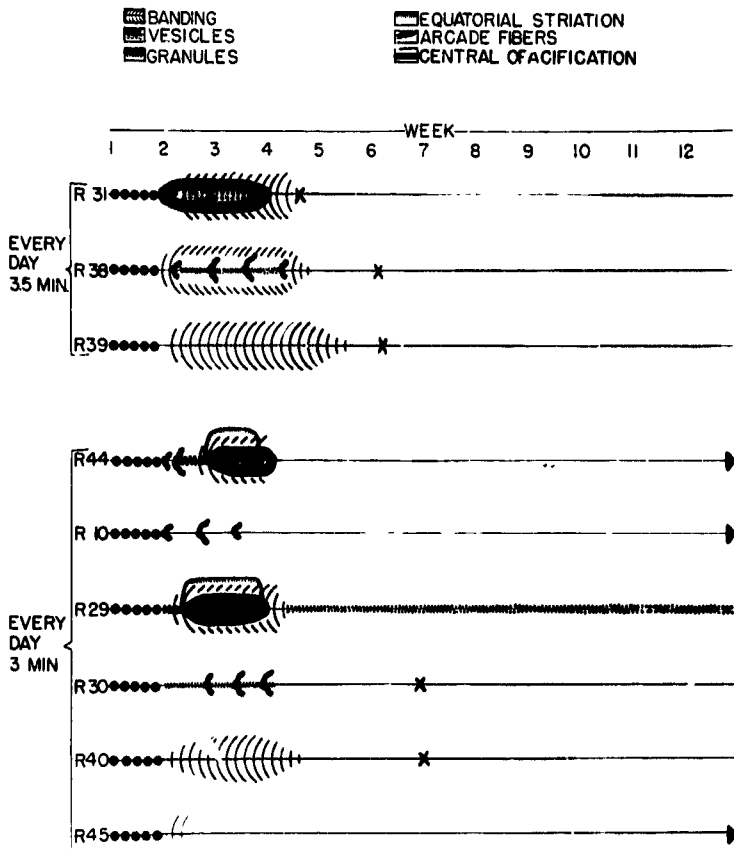

Figure 8. Effects of repeated subthreshold exposures of  $3\frac{1}{2}$  and 3 minutes each, at a power density of 0.28 w/cm.<sup>2</sup>. Each solid circle represents a single exposure.

of exposure but this is not invariable; exposures separated by intervals of two weeks may cause frank opacities which remain as permanent lesions. It yet remains to be determined how long a period of time must intervene between successive exposures to microwave radiation in order for no cumulative effects to occur.

#### Effects of Pulsed Microwave Radiation.

Through the cooperation of the Raytheon Manufacturing Company, we were able recently to add to our microwave generator a circuit for pulsing the output at pulse repetition rates of 200 to 5,000 per second and at any predetermined duty cycle. It thus became possible to compare the effects of continuous wave and of pulsed wave radiation without introducing such variables as a different Magnetron tube or a different microwave director. To date, we have performed only a preliminary series of 16 experiments, upon which I shall report briefly.

We first established that the thermal effect of pulsed wave radiation is directly related to the average power of the R-F field. For example, when the eye is subjected to pulsed wave radiation on a 50% duty cycle and at an average power density of  $0.14 \text{ w/cm}^2$ , the temperature of the vitreous body increases at the same rate and to the same extent that it does when the eye is subjected to continuous wave radiation at  $0.14 \text{ w/cm}^2$  power density. Temperature curves for the vitreous body under the two conditions are identical, as shown in Figure 9.

It should be pointed out that when the radiation is pulsed on a 50% duty cycle and at an average power density of  $0.14 \text{ w/cm}^2$ , the

VITREOUS TEMPERATURES ASSOCIATED WITH THE  
 PRODUCTION OF OPACITIES BY CONTINUOUS WAVE  
 AND BY PULSED WAVE RADIATION

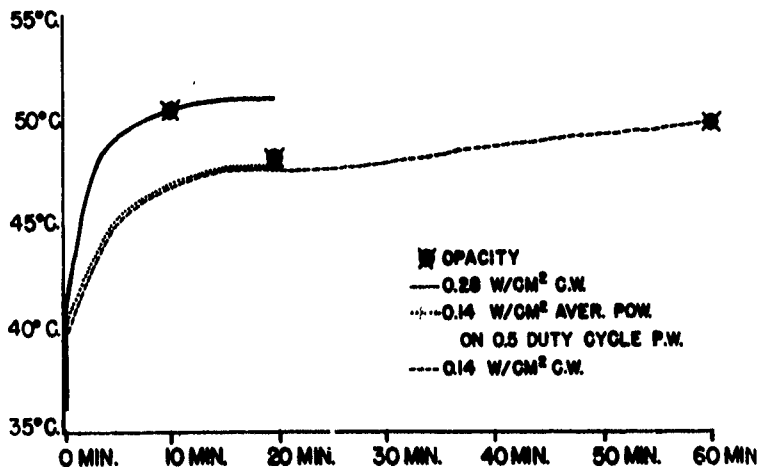

Figure 7. Vitreous temperatures associated with opacity-producing exposures of continuous wave (CW) and pulsed wave (PW) radiation.

peak power of each pulse is  $0.28 \text{ w/cm}^2$ , whether the pulse repetition rate be 200, 1,000 or 5,000 per second. Therefore, if we expose the eye for a single 20 minute period to microwave radiation pulsed on a 50% duty cycle and having an average power density of  $0.14 \text{ w/cm}^2$ , we set up the following conditions:

1. In terms of peak power, this exposure is identical to a 10 minute exposure to continuous wave radiation at a power density of  $0.28 \text{ w/cm}^2$ , which we have shown will cause lens opacities to form. (See Figures 1 and 3).

2. In terms of thermal effect, this exposure is identical to a 20 minute exposure to continuous wave radiation at a power density of  $0.14 \text{ w/cm}^2$ , which we have shown is not sufficient to cause opacities to form. (See Figures 1, 3 and 9).

Under the conditions described, we exposed the eyes of 12 rabbits and lens opacities developed in eight of them. The opacities varied from minimal ones, with granules, vesicles or arcade fibers along or near the posterior suture, to extensive lesions such as that illustrated in Figure 10. As in the case of opacities produced as a cumulative effect, some of them subsequently regressed and others remained as permanent lesions.

Four more animals were exposed for 20 minutes to radiation of  $0.14 \text{ w/cm}^2$  average power density but pulsed on a 25% duty cycle, so that the peak power density was  $0.56 \text{ w/cm}^2$ . Frank lens opacities developed in two of these cases, one of which was pulsed at a repetition rate of 200 per second and the other at 1,000 per second.

P-3 20 MIN. AT 0.14 W/CM<sup>2</sup> AV. POW. 0.5 DUTY C. PW.

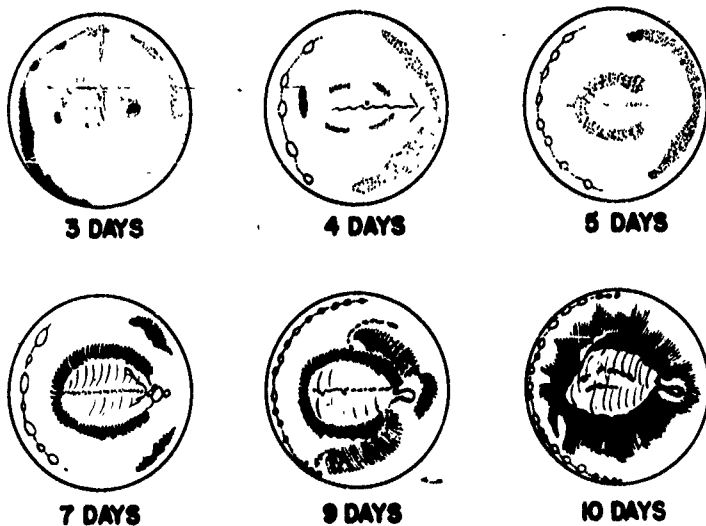

Figure 10. Stages in the development of a lens opacity resulting from a single 20 minute exposure to pulsed wave radiation. Duty cycle, 50%; pulse repetition rate, 1000/sec.; average power density, 0.14 w/cm.<sup>2</sup>; peak power density, 0.28 w/cm.<sup>2</sup>.

These experiments strongly suggest that the cataractogenic effect of microwave radiation at this frequency is not primarily a thermal effect, as we had tentatively concluded from our earlier experiments in which continuous wave radiation was employed. Control animals, the eyes of which were exposed for 20 minutes to continuous wave radiation at a power density of 0.14 w/cm.<sup>2</sup> did not develop opacities.

It is our opinion, therefore, that in considering possible hazards to personnel of microwave radiation, it would be advisable to pay attention to peak powers of the R-F field rather than to average powers.

REVIEW OF THE WORK CONDUCTED AT THE ST. LOUIS  
UNIVERSITY SCHOOL OF MEDICINE

by

Alfred W. Richardson, Ph.D.,  
Department of Physiology

SUMMARY

Introduction

Recognition should be given to Dr. Pietro Bramante, Mr. Walter Ciszczon, Mr. Donald Henson, Mr. Henry Wellman, and Mr. Peter Goetz for their aid in the execution of different specific portions of this work. This review includes work that is finished, and work in progress where sufficient data have been accumulated for limited conclusions to be stated.

Dosimeters

Dr. Ely, in my opinion, should be commended for his efforts in testing the Richardson dosimeter and I am in general agreement with his conclusions. It should be clarified that the dosimeters do not measure RF field strength per se, but rather respond as a calibrated analogue to the temperature rise in avascular tissues of the body. This dosimeter is affected by field strength and time of exposure, possessing a long time constant as Dr. Ely quite adequately described. If an investigator were in the field during the period of the meter response reported by Dr. Ely, the temperature in his testes and in his eyes increased  $4^{\circ}$  C. above the normal temperature. Dosimeters can be constructed with greater or less sensitivity than this. Modifications will be made for better ambient temperature compensa-

tion, for the prevention of arcing, and for more rugged construction.

#### 2450 Megacycle Decay Gradients in Tissues

Studies have been completed using tissues of the kidney, liver, eye, and whole blood to determine the penetration loss, or energy decay gradient, at this frequency. With a generator output of 0.1 to 0.3 watts per cm<sup>2</sup>, temperatures were measured at multiple depths in tissues at 2-second intervals. Kidney and liver specimens were excised with blood intact. Very early readings were the most reliable, before conduction into surrounding areas altered the established gradients.

Under the conditions as described, one-half of the energy was dissipated at each 0.8 cm. increase in depth, following a log-2 curve of half-loss. This was true within a close limit of error for the four tissues studied. The results of the plot may be tabulated as follows:

<u>Tissue Depth (cm)</u>	<u>0</u>	<u>0.8</u>	<u>1.6</u>	<u>2.4</u>	<u>3.2</u>	<u>4.0</u>	<u>4.8</u>
Energy Loss	0	1/2	3/4	7/8	15/16	31/32	63/64
Remainder	1	1/2	1/4	1/8	1/16	1/32	1/64

Current studies with the excised limb of the dog indicate that these sets of values do not hold, the layers of tissue being of a more heterogeneous character.

#### Animal Weight Changes with 2450 Megacycle Microwave Exposures

Although our accumulated data to support this finding is less extensive at present than that of Drs. MacAfee, Baus, and Fleming, it is believed that we have confirmed a portion of their work concerned with weight changes in rats. With repetitive exposures



7

of the animals to this frequency, we have found that the animals lose weight immediately after exposure for a short period. but weight is accelerated during periods of no exposure, back to control levels or above.

#### Longevity Experiments, in Progress

Groups of albino rats are in process of being exposed to microwaves in multiple irradiations of 5 to 50 mw/cm<sup>2</sup>, with the life-span being compared to controls. These studies are based on the hypothesis that longevity may possibly be the most sensitive test of microwave damage.

#### Exposure of Chicken Eggs, in Progress

In our procedure, eggs are irradiated with 2450 megacycle microwaves of such magnitude that the highest induced temperature within the eggs rises to 37-38°C. over a 100-minute period. After exposure, the irradiated eggs are placed in a 39° C. incubator along with unexposed controls. The embryos are compared at intervals. At present, 60 eggs are under study. At the time of this report, 12 eggs have been examined, 6 controls and 6 experimentals. Of the 6 exposed eggs, 5 have revealed various types of distinct pathology, the most overt finding being insufficient growth rate of the total embryo or its parts. As yet we do not claim an athermal effect here, since such a view would be premature. It is believed, however, that the results thus far are strongly suggestive of such an action. The results reported are 7-day embryos.

### The Irradiation of Vegetable Seeds with 2450 Megacycle Microwaves

A series of comprehensive studies have been carried out where lettuce and radish seeds have been exposed to microwaves from 1 to 20 minutes before planting with unexposed controls. The results have been considerably complex because of multiple conditions of exposure, and the results have been shown to be quite dependent on the exposure condition, but we have convincing evidence that microwave exposure influences germination time and growth rate. A prime example has been the 20-minute exposure of 50 radish seeds, compared to 50 control seeds. After a latent period of 18 hours, 36 of the exposed seeds had opened as compared with 18 of the control group. We do not know whether there is an athermal component in this action, but our evidence indicates a definite thermal component as a contributing factor. Our experimental conditions did not prevent the thermogenic function.

### Microwave Induced Pathology in the Rat

These studies have covered a two-year period, and include exposures to 2450 and 10,000 megacycles. Irradiations have been of two types: (1) exposures using field magnitudes of sufficient intensity to be lethal in 15 to 20 minutes, and (2) 10 to 20 repeated exposures of 25 mw/cm<sup>2</sup> which were sub-lethal, but which created progressive accumulative pathology in the various body organs. The body organs which have been studied include the brain, lungs, heart, liver, kidney, intestines, testes, and muscles. Organs have been studied grossly and histologically. Various pathologic alterations have been found in all of the organs under study. The

most prominent overt differences between the two types of studies was that the acute (1) series revealed hyperemia, congestion and vascular rupture, whereas the chronic series (2) demonstrated progressive fibrosis.

The results of the acute series are sufficiently similar to evidence reported by Dr. Hartman resulting from hyperpyrexia with concomitant anoxia that we would be willing to concede that these variables must contribute to our pathologic effects; especially in the acute exposure conditions. However, we have observed more vascular engorgement and vessel rupture in this situation, and in our chronic series fibrosis is definitely more prominent. We believe that our studies described below may explain some of these differences.

#### Arterial and Venous Pressure Changes in the Rat During Microwave Exposure

These observations using 2450 megacycle microwaves have utilized field densities of 70 mw/cm<sup>2</sup> and above, to result in a 15-minute lethal exposure time to the animals. Arterial pressures were measured in the femoral artery, and venous pressures were measured in the right atrium via venous catheterization. This study is still in progress.

After initiation of the irradiation, the right atrial pressure started rising within 2 minutes. From the second minute to fifteenth minute (death) the atrial pressure rose progressively up to 8 sm. of water pressure. Our group does not consider this total period of pressure rise to be a representation of dysfunction, but only the latter portion of the period between about the tenth to the fifteenth minute. It is my opinion that the first 10 minutes represents a combination of increased cardiac output and vasodila-

tation of peripheral arterioles. We would like to know if we can take the animals up to a point and then reverse the cardio-vascular system, as far as dysfunction is concerned.

The arterial pressure was progressively elevated after the first minute of exposure to twice its normal value within 5 minutes. It was maintained at this high arterial level from the fifth to the tenth minute of exposure, whereupon it began a precipitous decline to the end of the fifteenth minute (death). At this point it reached 15 mm. of Hg. Within 3 minutes after death, the arterial and atrial pressures were equalized.

Respiratory impairment observably began by the seventh minute. Serious dyspneic (labored breathing) distress was apparent from the tenth to twelfth minute, and respiration stopped at the thirteenth minute. The cardiac action continued to the end of the fifteenth minute, at which point action ceased.

As a result of these studies, it is my tentative opinion that the cause of terminal death from excessive microwave exposure is somewhat more complex than previously supposed. Serious impairment of both respiratory and cardio-vascular functions is involved. This work has been so fruitful that it will be continued until these relationships are better understood.

REVIEW OF THE WORK CONDUCTED AT THE UNIVERSITY OF ROCHESTER  
The Biological Effects of Microwave Irradiation in the Dog

By

S. Michaelson, R. Dundero, J. W. Howland

With the technical assistance of

K. Mahoney, L. Miller, & R. Thomson  
University of Rochester

This project is a cooperative effort between the Medical Division of the University of Rochester Atomic Energy Project and Colonel Knauf's group at Griffiss Air Force Base.

Our initial plans, on an essentially practical basis, are to simulate in large laboratory animals the maximum potential exposure to which a human being could accidentally be subjected, as well as to detect and characterize possible damaging effects of an acute or chronic nature. From this information it is hoped to establish a safe exposure level for personnel working with microwave generators.

The source of r-f power is a radar set AN/IPS-14 operating at a frequency of 2800 megacycles and producing in excess of 2000 watts of average power. The pulse type emission utilizes a 2 microsecond pulse width and a 360/sec pulse repetition frequency. The power densities available in the exposure chamber vary between the limits of 1.2 watts/cm<sup>2</sup> to less than 50 milliwatts/cm<sup>2</sup> depending upon distance from the antenna. In order to estimate the power distribution across the animal's body, contour lines of equal intensity have been measured and are presented in chart form. Analysis of the graphs indicates a relatively uniform field across the animal's body with the energy at the periphery

differing by less than 20 per cent from that at the center. Because of the intense r-f fields existing in the chamber it is impractical to perform measurements under high power conditions; therefore, a system has been devised whereby the power density at an arbitrary distance from the antenna is related to the power fed to the antenna. This procedure will be more fully explained when the group visits the Verona Test Site.

In order to simplify the determination of the power density and aid in the interpretation of data a microwave "free space" room was constructed for animal exposures. The exposure room, approximately 7' x 7' x 15', is lined with commercial microwave absorbing material. According to the absorbing material manufacturer, a maximum of 2 per cent of the energy will be reflected from the surface of the absorber. Under these conditions it is felt that we have approximately a "free field" for all practical purposes.

Those of you who have subjected animals to the power densities of the magnitude we are using are aware of the problems encountered in restraining animals (especially dogs). Although many workers in this field restrain their animals by utilizing general anesthetics or tranquilizers, we in Rochester have always avoided such premedication in ionizing radiation studies because of the physiologic changes induced in the animals. In our opinion the avoidance of such premedication is especially indicated in r-f exposure because of the hypothermic effect produced by anesthetics such as Pentobarbital and tranquilizers such as Chlorpromazine. Figure 1 includes data obtained on animals receiving such medication in our laboratory. It is quite obvious that both

Figure 1

RECTAL TEMPERATURE RESPONSE OF DOGS INJECTED WITH  
CHLORPROMAZINE OR SODIUM PENTOBARBITAL

Minutes After Injection	Change in Degrees Fahrenheit from Pre-Injection Temperature				
	Chlorpromazine 6 mgm/kg				Na Pentobarbital
	i.m.	i.m.	i.m.	i.v.	30-31 mgm/kg i.v.
5	-0.5				
10	-1.0				
15	-0.5				
20	-1.0				
25	-0.5				
30	-1.5				-2.5 -2.0
35	-2.5				
40	-2.5				
45	-3.0				
50	-3.5	-2.5			
55	-3.0		-2.0		
60	-3.0				
65	-3.0				
80				-0.5	
90					-4.0 -4.0
180					-6.5 -7.0
800					-6.5 -3.0

Chlorpromazine and Pentobarbital result in a hypothermia of significant duration.

Initial attempts were made to expose untreated animals in a nylon sling. (Figure 2). This proved impossible because as soon as the animal responded to increased power densities he began to struggle for release from the sling. It was felt that such struggling introduced a physiologic picture which would tend to alter the r-f response. At the present time an all plexi-glass cage is being used in the exposure of animals (Figure 3). This material has been chosen for its good dielectric properties and structural strength. Preliminary measurements on the cage indicate excellent transmissibility through the structure with a tolerable distortion of the field due to defraction. The cage has proven to be an effective solution to the restraint problem because not only can the dog move about freely but his actions are also easily observed and recorded.

Before presenting our results to date, we should like to interject a word of caution in interpreting these data. We must emphasize that these are preliminary findings and may be altered by future experiences.

Briefly, our procedure in carrying out these exposures is as follows: After preliminary standardization and training, mongrel dogs of comparable size from our colony in Rochester are transported weekly to the Verona Test Site in a station wagon, rested overnight, exposed, and returned to Rochester in the evening.

Dogs are exposed at three densities at different time intervals and durations. While the animal is being exposed his response is observed and recorded. Upon completion of the exposure clinical tests





FIG. 2

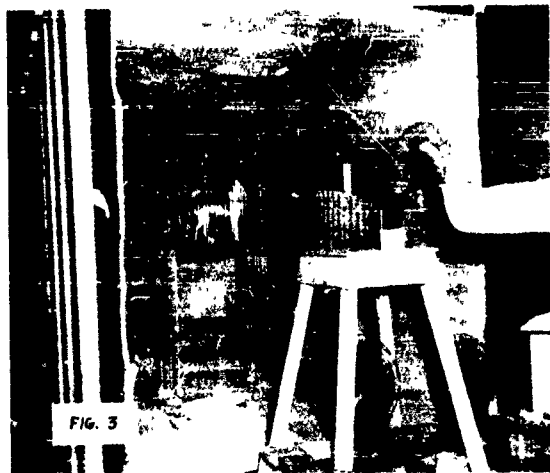

FIG. 3

are performed and compared with the observations obtained immediately prior to the exposure.

Those animals which are exposed are tested before placement in the cage. They are kept in the cage for 15 minutes to become adjusted during which time rectal temperature determinations are made at 5 minute intervals. Temperatures are recorded by using a model PSB Tri-r electronic thermometer. If there is no variation in temperature, exposure is started. Immediately after the prescribed exposure time, temperatures are obtained which in all cases require no more than 20 seconds after interruption of the power. Blood for hematologic examination is obtained from the jugular vein and venipuncture is accomplished within one minute after interruption of the power. After removal of the dog from the cage he is observed for obvious physiologic changes such as general appearance, alterations in gait, and desire and ability to drink water. At regular time intervals rectal temperature recordings are made to characterize the recovery pattern of the dog.

The next two figures (4, 5) summarize our results to date. The controls are dogs which are put in the cage, kept there for 75 minutes with the power off. Clinical determinations are made in the same manner as those in the exposed dogs.

Since the exposed animals quite often display considerable agitation and muscular activity, it is desirable in choosing control animals to use both active and placid dogs in an alternating fashion. The importance of this can readily be appreciated when it is noted that the active control dog displays a slight temperature rise, drop in hematocrit, and possible increase in reticulocyte count. These findings are

Figure 4

PHYSIOLOGIC CHANGES INDUCED IN DOGS  
EXPOSED TO MICROWAVES

Exposure 60 min. * 90 min. ** 120 min.	Response	Change From Pre-Exposure Value						B.S.F. % Reten- tion (15 min)
		Temp.(F)	Hct.	WBC $\times 10^3$	WBC / $\mu$	Reti.	Hgb. gm.%	
Controls								
<u>#4080</u>								
5-17	Active	+0.5*	-4.0	-1.5	-13	+0.4	None	
<u>#4047</u>								
6-24	Quiet	None	None	-0.6	- 8		-0.5	
7-1	Quiet	-0.5	-1	+0.45		-0.2	None	7
Low Power (45mw/cm <sup>2</sup> )								
<u>#4179</u>								
5-16	None	None	-5	-0.95	- 9			
5-23	None	None	-6	-1.90	-15			
5-28	None	None	-2.5	-1.05	- 8	None		
6-5	None	+1.5*		+1.55	+16	None		
6-11	None	-1.0*	-3.5	+0.90	+10	None		
Medium Power (100mw/cm <sup>2</sup> )								
<u>#4051</u>								
5-16	None	+2.5*	-1.5	-2.85	-21			
6-5	None	None	-5.5	-1.4	-12	None		
6-11**	None	+1.5*	-2.5	+8.5	+ 8	None		

consistent with those obtained after increased muscular activity.

As indicated on Figure 4, dogs exposed at the low and medium power level do not exhibit any marked changes as evidenced by the tests which were performed. Those changes which are recorded cannot be differentiated from those which could be due to muscular activity.

The next figure (5) indicates the response manifested by dogs exposed to the high power level. It is here that we see evidence of the radio-frequency effect. Our present interpretation of these effects would be that we are seeing a response to a thermal type of insult. In those cases where the response is designated as "marked," the dog exhibits signs of agitation, increased panting, and considerable movement, although for some reason the animal continues to face the horn. The temperature increases shown are those increases from the immediate pre-exposure level. All are obtained within 20 seconds of interruption of the exposure while the animal is still in the cage. The hematologic changes such as increased hematocrit may be indicative of a hemoconcentration or decreased blood volume consistent with the physiologic response to thermal exposure. The reticulocyte increase, although slight, seems to appear only in the dogs exposed at the high power level with no changes observed in the medium or low power level. This change may be a redistribution phenomenon, although the possibility exists that a mild hematopoietic stimulation may occur. The hemoglobin increase may relate to a hemoconcentration effect from a shift in water balance.

After the first few exposures it was further noted that the dogs exhibit considerable vasodilation as evidenced by reddening of the light

ably applies to somewhat longer times of exposure. The short exposure whole body value of Ely and Goldman was intended to apply to times measured in minutes rather than seconds.

### Findings

Examination of the field strengths determined by measurement promptly discloses that the only fields which were significant in terms of the suggested permissible levels were those from the AN/APS-20E airborne radar while the aircraft was on the flight deck, radiating with a stationary antenna. The values were 14 mw/cm<sup>2</sup> at 25 feet and 70 mw/cm<sup>2</sup> at 18 feet. Somewhat, although not greatly higher values would be expected at closer range. Standard operating procedure for this radar calls for use of a dummy load until the unit is airborne, and rotation or sectoring of the antenna when radiating. The test conditions were artificial and field strengths of this magnitude would not be expected under normal operation.

All other measured fields were very low. With the exception of the APS-20, the only higher power radar antenna were high above flight deck level on the island structure. Personnel exposures close to these antennas would be unlikely or almost impossible due to their location, and the environmental hazard due to stack gas would probably be overriding in any case.

### Conclusion

It is concluded that personnel damage from RF fields aboard the U.S.S. Forrestal would be extremely unlikely, and could result only from an improbable combination of unfortunate events, deviations from the standard operating procedure, and intent.

Figure 5

PHYSIOLOGIC CHANGES INDUCED IN DOGS  
EXPOSED TO MICROWAVES

Exposure	Change From Pre-Exposure Value						B.S.P.	
60 min.				WBC	WBC		% Reten-	
* 90 min.	Response	Temp.(F)	Hct.	X 10 <sup>3</sup>	%	Retis.	Hgb.	tion
** 120 min.							gm %	(15 min)
High Power (155m./cm <sup>2</sup> )								
<u>4143</u>								
5-16	Prostrate	+8°	+4	-1.25	-24			
5-23	Marked	+2°	+0.5	-0.3	-4			
5-24	Marked	+3°	+1	-0.4	-20	+0.2		
6-5	Marked	+3.5°	+3	-2.6	-2.5	+0.2		
6-11	Marked	+2.5°	+7	+1.05	+10	+0.1		
6-17	Marked	+4°	+5.5	+4.3	+7.3	+0.2	+2.5	13
6-24	Marked	+3.5°	+5.5	-1.8	-27		+2.0	
7-1	Marked	+4.0°	+3.0	-2.5		None	None	20
<u>4152</u>								
5-17	Marked	+3.5°	+7	-2.45	-19	-0.1	+2.5	18
6-24	Marked	+5.5°	+10.0				+3.5	
7-1	Marked	+5.5°	+9.5	-1.6		+0.1	+1.5	720
<u>4307*</u>								
5-17	Marked	+3°	-1	-0.60	-5	+0.1	+1.5	7
6-24	Marked	+5.5°	+0.5	-0.30	-3		+1.0	
7-1	Marked	+5.0°	+1.5	-1.05		-0.2	None	9

colored and hairless areas of the body. There is considerable congestion of the buccal mucosa and ocular conjunctiva. The corneal and retinal vessels appear quite dilated. The increased bromsulphalein retention may be indicative of an hepatic congestion associated with the general vasodilation and slowing of the blood flow. In the one instance in which the dog became prostrate, typical signs of heat exhaustion or heat stroke developed. The animal displayed marked panting with gradual onset of respiratory distress. Weakness developed to complete prostration at the end of the one hour exposure. Upon removal from the cage the animal remained quiet but after two or three minutes started walking with a staggering gait, marked weakness, and a staring expression. This disruption of equilibrium was severe as evidenced by the animal actually walking into objects. Water was refused when offered. Gradual recovery occurred over the next three hours.

Repeat exposures of this animal at weekly intervals produced a less profound effect in both signs and temperature elevation. This might suggest that a tolerance to the exposure is developing. Whether such "tolerance" in response is a real effect or related to the normal variation of the animal is yet undetermined.

In general it was noted that the more marked the response to the exposure, the less willing was the dog to drink water when offered. This parallels other observations on heat exhaustion in both animals and man.

After cessation of the exposure, rectal temperatures were obtained on the dogs at frequent intervals to determine the recovery rate.

Figure 6 indicates the thermal recovery rate among the exposed animals at the various power levels. Additional data obtained since this curve was drawn seems to make the curve a little more sigmoid. The fall during the first 5 minutes after exposure is slow with rapid drop over the next 25 minutes at which time most dogs return to their pre-exposure level. From then on there is a slight but definite decrease in temperature below the pre-exposure level.

Upon return to Rochester between 4 and 12 hours after exposure all the animals to date have shown normal body temperatures as well as normal appetite.

One incidental finding which might be of interest occurred when one of the exposed dogs showed signs of oestrus at the same time that a control dog came into heat.

Coincidentally with our main objective, it was of interest to compare the response of the tranquilized dog with a normal dog, since tranquilization might enhance the hazard to microwave exposure. Two dogs were utilized and premedicated with Chlorpromazine one hour before exposure in the r-f field in a "cross over fashion;" in other words, dog 1 was premedicated while dog 2 remained untreated, on the following week dog 2 was premedicated while dog 1 remained untreated. Figure 7 indicates the response in these two dogs. On the surface it would appear that the tranquilized dog did show a more marked response to the microwave exposure than did the untreated dog. This presents evidence toward contraindicating the use of premedication in dogs exposed to the radiofrequency field.



Figure 6

... TEMPERATURE RECOVERY IN DOGS EXPOSED TO MICROWAVES ..

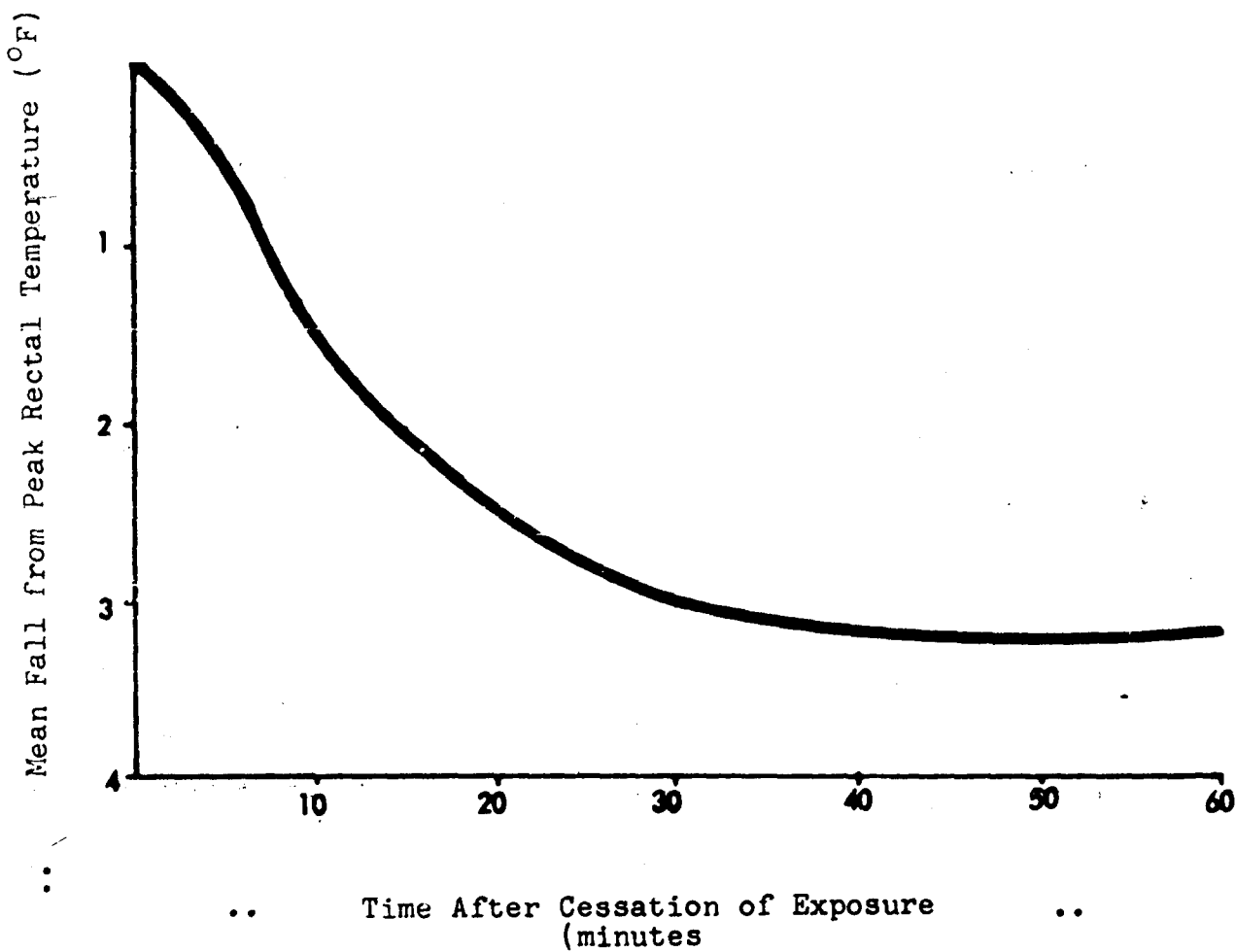

Figure 7

## RESPONSE OF TRANQUILIZED DOGS TO MICROWAVE EXPOSURE

Response	Test	Untreated		Treated	
		Dog		Dog	
		1	2	1	2
General Response	1	minimal		minimal	marked
	11		slight		
	111	marked		minimal	marked
Rectal Temperature Change (*F)	1	+ 2.0		+ 4.0	+ 6.0
	11		+ 4.5		
	111	+ 3.0			+ 7.0
Hematocrit Change	1	- 1.0			+ 3.5
	11		+ 0.5	+ 4.5	
	111				

In summary, when dogs are placid in an r-f field of sufficient intensity, immediate and post exposure responses resemble those of a thermal insult and appear to be entirely transient with complete recovery. Although sufficient time may not have elapsed, no latent or residual effects of microwave exposure have been demonstrated with present methods of measurement upon repeated examination.

In conclusion, we must again emphasize that the results presented today are quite preliminary and too much importance should not be placed upon them at this time for the purpose of determining the maximum permissible exposure.

The Rochester-Rome group would be very willing to consider recommendations for further tests which it may be in a position to perform in order to elucidate the physiologic response of the dog to radiofrequency exposure.

REVIEW OF THE WORK CONDUCTED AT UNIVERSITY OF BUFFALO

Studies on the Biological Effects of 200 Megacycles

by

C. Addington, F. Fischer, R. Neubauer, C. Osborn,  
Z. Sarkees and G. Swartz  
The University of Buffalo

PART I

Electrical Facilities and Instrumentation  
for the 200 Mc Frequency Employed

Since the wavelength at 200 mc is 1.5 meters, antennas, anechoic chambers, absorbing materials, and active spaces in general must be relatively large.

TRANSMITTER I

The first transmitter employed in the University of Buffalo facility was a pulsed one; Model SCR 627A, 200 mc, 5-microsecond pulse width, 800-cps repetition rate, peak antenna input power 75-110 kw, and average antenna input power 300-450 watts.

The anechoic chamber consisted of a sheet metal enclosed room; the metal is fastened to a wooden structure, the total exterior dimensions being 23 ft. long x 10 ft. wide x 9 ft. high. Echosorb, consisting of pyramidal shapes with a non-absorptive top slab, with a total depth of 19 inches, lined the interior of the chamber. Suitable openings, similarly protected by moving doors, allowed entrance to and exit from the enclosure. A blower ventilated the enclosed facility.

A folded dipole and 90°-corner reflector assembly was used as an antenna which was polarized in the horizontal direction. The transmission line was a parallel pair, balanced to ground.

The transmitter was located in the anechoic chamber.

Most of the biological specimens were exposed in a region where the peak power density was  $0.045 \text{ watt/cm}^2$ .

This chamber, although delivering too low a value of power density for thermal effects, did give the group excellent testing time for the possible existence of athermal effects, as well as an opportunity for perfecting field measuring techniques on a point by point basis.

The need for a new facility with higher power density became apparent.

#### TRANSMITTER II

The new anechoic chamber is 42 ft. long x 10 ft. wide x 9 ft. high and lined with Echosorb as before. A TETRAH R.C.A. television transmitter (visual portion) with 6 kw continuous wave input to the antenna was procured. An end fire helical antenna was designed which was fed by a 3-1/8-inch coaxial line from the transmitter. The helix consisted of 5 turns, possessed a 72-inch length and a 22-inch mean diameter. A 6 ft. x 6 ft. ground plane was employed. The transmitter was located in an adjacent room.

A range of average power density from  $0.6 \text{ watt/cm}^2$  to  $0.015 \text{ watt/cm}^2$  has been observed by merely moving along the long axis of the chamber. The range can be extended still further at each end although the high power densities referred to are in the near field including the induction fields.

#### INSTRUMENTATION

##### (a) Field Strength

Field strength measurements are taken essentially at a point

in air by a small non-resonant dipole or loop in a calibrated system involving transmission line, baluns, attenuators, crystal detectors and output devices. If a continuous wave is monitored, a d-c galvanometer is a suitable output device. A Tektronix scope and an envelope detector work well with pulses. A Stoddart RI-FI meter model NMA-5A serves as a secondary standard to calibrate the detector system against (exclusive of antenna and transmission lines) when this system is energized directly by some driving point oscillator. The Stoddart meter could never be used directly in the electromagnetic field or in the external leakage field because of the penetration of these strong fields into the instrument. Once the detector system is calibrated, the small loop or dipole may be compared against the resonant antenna supplied with the Stoddart instrument, but used with the detecting system when each receiving antenna is immersed in the same macroscopic far field of some separately excited antenna. The entire system can thus be calibrated with any special attenuator settings possessing their own individual calibrations.

The foregoing system works very well in the far field of an antenna to be measured since points of zero electric field intensity can be found for the lead-in wire. In the near field, the amplitude of the various components of the E vector (with dipole) and H vector (with loop) can be measured essentially at a point within the limits of field distortion caused by the lead-in wires.

When the sampling dipole or loop is immersed in a specimen, the calibration is not necessarily the same as when the sampling probe is in air. By experimentally measuring the sampling antenna

impedance with said antenna in the anechoic chamber immersed first in air and then in the specimen, corrective constants can be applied to the air calibration.

It is believed that the actual field intensities at a point are more meaningful parameters than the free space power densities.

(b) Temperature Measurements.

Temperature measurements are made with thermocouples and thermistors. "Far" measurements are made with the lead-in wires immersed in a minimum electric field region. The thermocouple lead wires are also twisted as they enter the specimen at which point radio-frequency chokes are formed with the wires. Shields are employed the remaining distance to the recorder. When in the near field, if rf pickup is still a disturbance, a final accounting of error is resolved with cooling curves where two time constants are displayed. A short one represents the thermal probe and its immediate environs of specimen. The long one represents the a portion of the specimen in a much larger region sampled by the probe. The minimum requirement is that the thermal increment of temperature due to the probe and immediate environs must be subtracted out, or the temperature must be read when this thermal transient has died away. This does not account for the general temperature rise of the larger region sampled by the probe and due to the probe. Many times it is neglected or rightfully considered a temperature, producing thermal effects. Plotting the thermal transient logarithmically will allow one to read what would have happened if no probe had been present and is a last resort method if such information is considered necessary.

## PART II

### Ophthalmological Studies

This is a review of the ophthalmological portion of the work being done at the University of Buffalo in the 200 megacycle band. Results of our earlier experiments have been presented at the last conference of investigators in the Spring of this year. These results will now be presented in brief summary for your consideration. You have been appraised of the power intensities available by Dr. Fisher in both our original and more recent studies.

Our low power experiments were carried out using a machine giving peak emanations of 0.04 watt/per sq. cm., with an average level of about 1/200th of this power. These studies cover a nine month period beginning in August 1957. Our original work was done on mice. These mammals were chosen because of the advantage of comparing large numbers which would be technically difficult if larger animals such as dogs or sheep were employed. We also knew that there were a number of inbred strains available with known characteristics and known hereditary patterns. The ease of handling and housing mice is, of course, quite obvious as compared to larger animals. In addition we thought that the use of these smaller mammals would allow us to interpret more quickly the long term ocular problems which might be involved. From our knowledge of the course of events in human beings, it is not unusual to find cataracts developing ten, twenty, thirty or even fifty years following an original injury. This is such a well established principal that if a person presents himself with a monocular cata-



ract and a perfectly normal lens on the opposite eye, we are forced to draw the conclusion that the cataract eye had been injured at some time in the past even if a history of such injury is not available.

We also had at our disposal a limited number of guinea pigs for estimation of results in animals with larger body size.

All of our observations were made with the slit lamp. We do not feel that the ophthalmoscope or the hand slit lamp is adequate especially in smaller animals. Opacities might be recognized with these instruments but their depth in the lens would be difficult to ascertain. In addition, we felt that minimal or early lens changes might be missed if adequate magnification was not used.

Both white and brown colored mice were used in these experiments. The mice were placed in plastic tubes and rotated on turntables 4 feet from the antenna. In this manner, 7 groups of mice were exposed to our available radiation at the following intervals: Group I, five minutes per day five times a week for a total of 550 minutes; Group II, ten minutes per day five times per week for a total of 1000 minutes; Group III, twenty minutes per day five times a week for a total of 1800 minutes; Group IV, sixty minutes per day five days a week for a total of 4200 minutes; Group V, sixty minutes per day five times a week for a total of 4500 minutes. A second experiment was carried out with the mice at 18 inches from the antenna. A group of white mice were exposed in this manner five minutes a day five days a week for a total of 150 minutes; a second group of brown mice were exposed five minutes per day five days a week for a total of 180 minutes; and a third

group of brown mice were exposed 20 minutes a day five days a week for a total of 180 minutes. Two groups of brown mice were then exposed at 18 inches and 30 inches from the antenna for a total of 135 minutes respectively at one continuous exposure. A group of guinea pigs was exposed at 4 feet from the antenna 90 minutes per day five days per week for a total of 27,000 minutes. These exposures have been logged in minutes for your convenience in comparison with the results obtained by other investigators using different wave lengths.

### RESULTS

1. No clear cut evidence of lens changes were found.
2. We have had a few instances of minimal changes in our longest exposures. These consisted of "banding" in the posterior and anterior cortex as described by Dr. Carpenter. However, these changes were evanescent and not consistent. Eventually these groups did not differ materially from the normal aging process in the controls.
3. We have had no incidence of the classical posterior sub-capsular cataract formation characteristic of heat cataract or any evidence of the posterior subcapsular toxic type of response similar to that seen in diabetes or other endocrine disfunction.
4. There were no changes in the body temperature in any of these experiments.

We now proceed to an evaluation of our results to date in a new phase of our work employing a C. W. transmitter with a power density at 10 feet of 0.04 watt/cm<sup>2</sup> and at 2 feet of 0.60 watt/cm<sup>2</sup>. Using this new apparatus we have to date performed the following

experiments; mice have been exposed at five and thirty-minute intervals at 10 feet from the antenna, guinea pigs at five, ten and sixty-minute intervals at 10 feet from the antenna, guinea pigs from two to four hours continuously at two feet from the antenna.

In all of these groups we have not seen any ocular changes so far. The body temperature of mice did not exceed 30° Fahrenheit over that of the normal. The body temperature of the guinea pigs rose in some instances to 107° Fahrenheit when the animals were placed two feet from the antenna.

We are not prepared to report on our results in larger animals, e.g. dogs.

#### CONCLUSIONS

1. There have been no consistent ocular changes of any kind in any of our experiments at the 200 megacycle range.
2. We are not as yet in a position to evaluate any long term effects on the ocular apparatus which might possibly be associated with microwave radiation.

#### PART III

You have heard something of our problems and progress concerned with transmission, power density measurement, temperature instrumentation, and observations which have been made in connection with our studies on the eye. This section represents a truly preliminary report on a variety of other studies we have initiated using particularly biological organisms other than mammals.

For a considerable period of time, early in our work (while

our transmitter was still producing pulsed waves at a very low intensity), a number of tests on a variety of simple and readily obtainable organisms were carried out in an effort to discover whether one might locate an organism which would be readily and dependably effected by irradiation at this wave length. If such a thing as an LD<sub>50</sub>, or a marked change in growth rate, a substantial change in the population density of a culture of micro-organisms, etc., could be identified which could be used dependably as a biological unit, such as is done in pharmacology and endocrinology, it was felt that a unit of real value might emerge which could be used in practical situations such as Dr. Vosburgh of the General Electric Company has already referred to.

Among the organisms exposed to 200 mc irradiation at time intervals varying from one minute to one hour and at field intensities not exceeding 0.04 or 0.05 watt/cm<sup>2</sup> were several protozoas including amoebae, paramecia; some worms including the vinegar eel; certain beetles and flies; and on the botanical side, cultures of bacteria and fungi at the time intervals employed and the low power densities available. We did not identify any reliable response among organisms tested which we felt could be employed as a biological unit. It is our opinion, however, that this objective remains an important one, and as soon as the opportunity permits, we intend to return to this part of the project using higher field intensities and longer periods of time, if necessary.

Next, we have attempted to learn whether radio frequency irradiation at 200 mc has effects upon the fertility, differentiation, and proliferation of embryonic materials. Accordingly, we have irradiated

fertile hens' eggs at a variety of time intervals varying from one to seventy-two hours in specific experiments and changing the time of irradiation in such a manner that in certain experiments all of the irradiation was carried out before incubation, in others all of the irradiation occurred after 72 or 96 hours incubation, while still others, the irradiation took place at an intermediate time after part of the incubation had been accomplished and followed by sufficiently more incubation to add up to a total of 72 or 96 hours of incubation. To date approximately two hundred dozen eggs have been used and the following kinds of observations recorded: (1) the general appearance of the embryo (size, shape, stage of development, etc.), (2) percentage of sterility, (3) diameter of the blastoderm taken in line with the umbellical mesenteric vein (at right angles to the long axis of the embryo), (4) crown rump length, (5) rate of heartbeat at a standard temperature, and (6) segmentation of the brain, appearance of the limb buds, appearance and size of the allantois and certain other organs particularly observed in embryos which had been subjected to longer periods of incubations. During these studies we have encountered a number of interesting and we think somewhat unusual developments, but in view of the fact that it is difficult to determine from our experience and from the literature how often some of the slight atypical developments we have seen may occur in eggs not subjected to radio frequencies, we are not convinced that 200 mc has any uniform and dependable effects on the early stages of embryonic development in the chick. The frequency of variations in the controls was essentially the same as that referred to in the irradiated eggs above.

We are at the present time in the midst of an experiment in which we are irradiating and incubating eggs concurrently. We believe this may be a critical experiment and await the results with great interest.

Some of our previous work suggested to us the advisability of making temperature studies in mammals of different sizes. It seemed not unlikely that much of the energy at this wave length might pass all the way through the body of small animals such as mice or rats, with very little absorption taking place which presumably could have such effects as temperature elevation and possibly other effects not related to temperature. On the other hand, larger animals such as perhaps guinea pigs or rabbits might be expected to absorb more of the energy and therefore a greater change in temperature or other effects be observable. Still further, if one is to consider a larger mammal such as a dog or perhaps a man, it might be reasoned that less of the energy would pass all the way through and out the other side, but more would be absorbed to produce whatever effects are possible.

Accordingly, mice weighing 35 to 45 grams were irradiated for periods of six hours at 0.6 watt/cm<sup>2</sup> intensity. Temperature studies revealed that body temperatures in the range of 104° to 105° could be reached and that a weight loss of approximately 2 grams per animal occurred but we have had no deaths to date among these animals. As a representation of a somewhat larger mammal, we used guinea pigs of small size (1 - 2 pounds) and larger sizes (2 pounds and over) which we irradiated in front of our helical antenna for periods of four hours at a field intensity averaging

0.6 watt/cm<sup>2</sup>. Rectal temperatures were taken at intervals and were found to ascend as high as 106° - 107°. In one instance the temperature was recorded beyond the calibrated limits of an ordinary rectal thermometer and was judged to be approximately 109°. Incidentally, this animal was the largest of the guinea pigs irradiated and succumbed approximately 1 hour 45 minutes after the irradiation period. This is the only animal in this size group which we have lost to date.

To represent a larger size group, we selected a 47-pound dog which was irradiated one hour under nembutal anesthesia at approximately five feet from the antenna. At this point the field intensity was 0.05 - 0.06 watt/cm<sup>2</sup>. At the end of one hour this animal's rectal temperature exceeded 110°. The irradiation was terminated and the dog died approximately 35 minutes after the irradiation period.

Feeling that it was advisable to try to learn more about the heat and penetration characteristics of 200 mc in animal tissues, it was decided to pursue such work temporarily with non-living masses of flesh (in order to obtain such information we selected a 60-pound mass of horse meat in a single piece which dimensions were roughly comparable to the cross section of the largest part of a man's torso). This was solid muscle with a small amount of superficial or subcutaneous fat adhering to it and with a segment of upper femur running through it. This mass was suspended at approximately two feet from the antenna where the field intensity was 0.6 watt/cm<sup>2</sup>. Irradiation was continued for eleven hours and temperatures were taken at frequent intervals using thermometers. The highest temperature recorded in the muscular tissue was 84.5°C.

on the front aspect toward the antenna approximately one inch below the surface. Higher temperatures were recorded in the bone but in view of the fact that we doubted the dependability of the thermometer, we ran experiments in which fresh femurs were suspended for irradiation at a position comparable to that described above. The marrow of these bones was observed to heat up disproportionately fast and before an hour had elapsed, the front portion of the marrow was observed to be boiling and temperatures well over 100°C. were recorded.

Briefly, we may summarize all findings to date by indicating: (1) 200 mc is found to be an extremely difficult range in which to work experimentally both from the point of view of instrumentation and from the point of view of gaining dependable and consistent biological effects. (2) To date we are not convinced that effects have been detected in the various test organisms used which can be attributed to anything other than temperature. It will be possible to keep in mind that the vast majority of our work was done at extremely low power intensities and that we are only getting a good start with our new transmitter at substantially higher power densities. We are enjoying the close collaboration of engineers and biologists and believe that by coordinated planning we may be able to provide some information which may prove of real value.



## REVIEW OF THE WORK CONDUCTED AT TULANE UNIVERSITY

### Investigations of the Biological Effects of Microwave Irradiation\*

By

Robert T. Nieset, Rene Baus, Jr.,  
Robert D. McAfee, Julius J. Friedman,  
Alvin S. Hyde, Joseph D. Fleming, Jr.

#### 1.0 INTRODUCTION

The investigation carried on under the Biophysics Program of Tulane University to determine the biological effects of microwave irradiation has consisted of two different approaches to the subject. The first was a purely physical study of the mechanism by which microwave energy is converted into heat. To this end the complex dielectric constants of body tissues were measured and microwave scattering studies were undertaken.

The second was the characterization of the physiological response to microwave induced stress, and, in particular, the determination of the effects of microwave irradiation at 3 and 10 cm. on small laboratory animals (e.g. CF-1 mice). The following effects of microwave irradiation have been found.

#### 2.0 HISTOLOGICAL STUDIES

Histological evaluations of the tissues of 270 mice that were subjected to a wide variety of radiation dosages showed no significant changes as compared to controls. Abnormalities appeared in both groups with equal frequency. The mean values of hemoglobin concentration,

---

\* This research was supported by the Office of Naval Research under Contract Nonr-475(03) with the Biophysics Laboratory, Tulane University, New Orleans, Louisiana.

white blood cell, and differential white cell count did not vary from controls; however, the standard deviation of these counts was found to be twice as great in the irradiated group; in fact, marked extremes of leucopenia and leucocytosis were found in the irradiated group and only in that group. After noting the lack of histological response to microwave irradiation, it was decided to abandon these studies; however, the library of tissue slides accumulated to date has been kept intact and available for re-evaluation should additional evidence indicate the need for such action.

### 3.0 EFFECTS OF 3 CM AND 10 CM MICROWAVE IRRADIATION ON BODY WEIGHT

Significant changes in body weight were found to occur among mice that were subjected to either acute or chronic irradiation dosages.

#### 3.1 Effects of Single Exposures to 3 cm. Microwaves

Irradiation of 90 mice with a single exposure of 0.220 watt-min/cm<sup>2</sup> at an average power of 0.06 watts/cm<sup>2</sup> raised their intraperitoneal (IP) temperature to 40°C. (Figure 1), and caused marked lag in growth rate (when compared with controls) at 3 and 7 days post-irradiation. The growth rate then became accelerated and surpassed control values by the twentieth day post-irradiation.

A second group of 44 mice was irradiated with a single exposure, 0.070 watt-min/cm<sup>2</sup> at an average power of 0.02 watt/cm<sup>2</sup> - a dose which did not elevate their body temperature above the normal 37-37.5° C., and their growth was compared with both a control group (18 mice) and the 90 mice previously mentioned. This group was categorized as a non-thermal effects group.

FIG. 1 EFFECT OF ACUTE IRRADIATION ON BODY WEIGHT

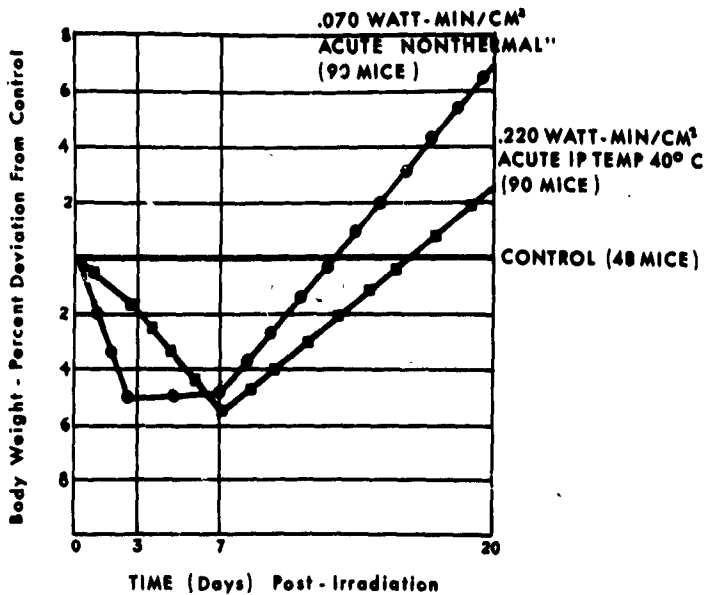

It appears (Figure 1) that the lesser dose caused an initial 5 per cent lag in body weight, followed by a 7 per cent increase in total body weight some three weeks after irradiation.

Considering that the data from the non-thermally irradiated group tended to fall along a curve similar in shape to that of the thermally irradiated group (that is, the first group which was raised from normal body temperature - 37°C. to 40°C.) the response to a single dose does not appear to be entirely a function of whether exposure is accomplished with or without elevation of body temperature. Further, since a greater growth lag and subsequent gain was seen with less than one-third the dose given the group, it is not believed that the magnitude of exposure was the sole critical determinant with respect to growth.

### 3.2 Effect of Multiple Intermittent 10 cm. Irradiation on Growth

Multiple exposure to 10 cm. irradiation of 8.6 watt-min/cm<sup>2</sup> divided into 432 doses resulted in an increase in the growth rate of mature mice of from 4 to 6 per cent with a maintained increase in body weight above that of the control animals (Figure 2). Older mice exhibited smaller increases of approximately 2 per cent in body weight. Thus it would appear that the effect of weight gain was somewhat dependent upon the stage of growth of the experimental animal.

Multiple exposures to 3 cm. irradiation of 2.9 watt-min/cm<sup>2</sup> in 12 doses resulted in progressive lag in growth (Figure 3). It should be noted that the total dose of 3 cm. irradiation is one-third that of the 10 cm. group.

The increase in weight of the 10 cm. irradiated group may represent favorable gain in tissue mass and/or an increase in tissue fluid.

**FIG 2 - EFFECT OF 10 CM CHRONIC IRRADIATION  
ON GROWTH OF CF-1 MICE**

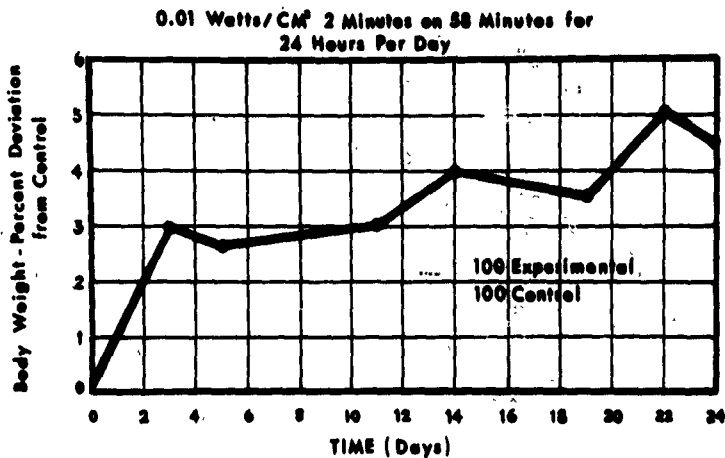

**NOTE: Body Temperature During Irradiation Was Not Raised  
More Than 0.25 C° Above Normal**

FIG. 3 EFFECT OF 3 CM CHRONIC IRRADIATION ON GROWTH

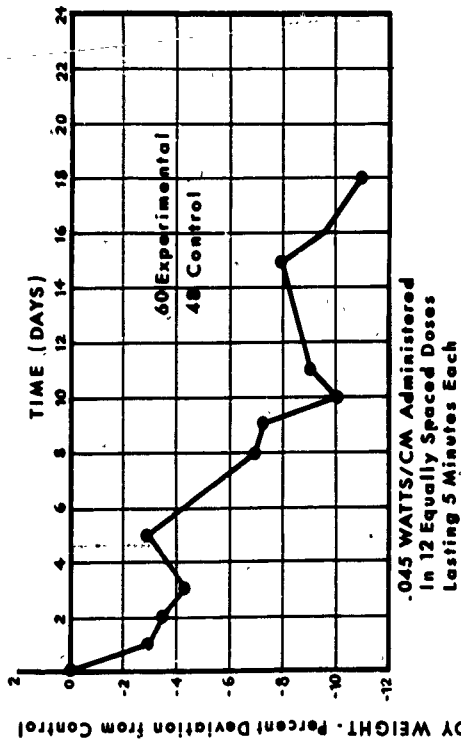

NOTE: During Exposure I.P. Temperature Reached a Value  
3 Degrees Centigrade Above Normal

The weight loss of the 3 cm. irradiated group may also reflect changes in tissue hydration and/or a reduction in tissue mass. Wet weight and dry weight tissue studies are being undertaken to determine the role played by metabolism and tissue hydration in effecting the change in body weight.

#### 4.0 CIRCULATING AND TISSUE PLASMA VOLUME STUDIES OF ACUTE 3 CM IRRADIATION

Nembutalized, male, albino mice, weighing 18-20 grams were irradiated with 3 cm. microwaves at two dose levels. The greater dose was at an average power of 0.060 watts/cm<sup>2</sup> for 4 minutes, and the lesser dose was 0.014 watts/cm<sup>2</sup> for 5 minutes. Human serum albumin labelled with I-131 was employed as the plasma indicator. Tissue plasma volume was calculated as the ratio of radioactivity per gram of tissue to the radioactivity per milliliter of plasma. Circulating plasma volume was measured by the dilution method.

Control animals were anesthetized and manipulated in a manner identical with the experimental animals save for exposure to microwaves.

Figure 4 shows the changes in circulating and tissue plasma volume which result from a single dose of 3 cm. microwave irradiation at two intensities. The changes in tissue plasma volume are plotted as the per cent deviation from the control tissue volume expressed as per cent of body weight. Each point represents the mean of 12-16 independent animals.

In general, the alterations in tissue and circulating plasma volume, following both dose intensities, were parallel, varying only

FIG 4 - EFFECT OF ACUTE 3 CM IRRADIATION ON  
TISSUE PLASMA VOLUME OF CF-1 MICE

■ HIGH DOSE (.22 WATT-MIN/CM<sup>2</sup>)

● LOW DOSE (.07 WATT-MIN/CM<sup>2</sup>)

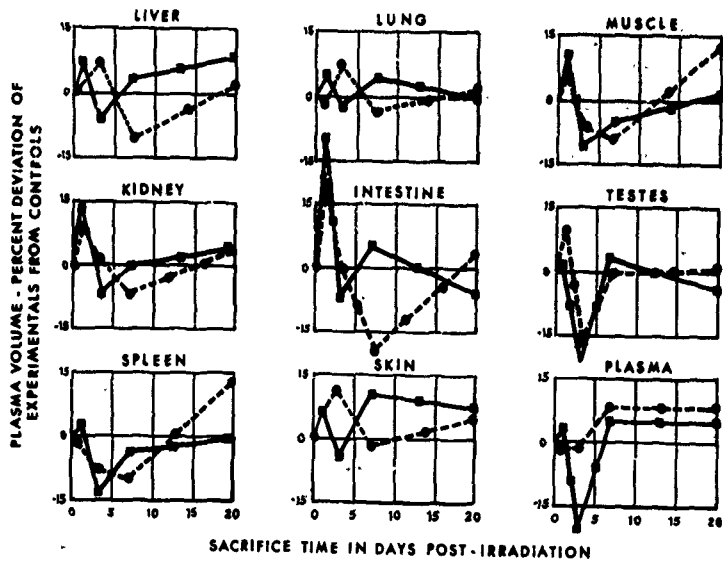



in order of magnitude. This general response is characterized by a slight rise during the early post-irradiation period, followed by a return to or below normal and then finally by a subsequent rise to or above normal.

This alteration in circulating plasma volume following high irradiation with the larger dose did not differ significantly from those observed with less exposure, except in the magnitude of the early decline. Both intensities of irradiation produced a subsequent rise in circulating plasma volume reaching a level of about 7 per cent above control at 20 days post-irradiation.

The rise in plasma volume exhibited by some tissues concurrent with a decline in circulating volume during a period when total body weight has declined sharply, suggests an alteration in tissue mass; that is since tissue plasma volume is expressed as volume of plasma per unit weight of tissue, a reduction in tissue mass would create an apparent increase in tissue plasma volume.

#### 5.0 MEMBRANE STUDIES, PRELIMINARY RESULTS

The possibility of cellular, extracellular volume changes occurring as a result of microwave radiation suggested electrolyte disturbances, either as a direct result of radiation, through heating effects, or through hormonal mediation. The short circuited isolated membrane preparation of Ussing and Zerhan (4) was investigated as a possible approach to the study of membrane effects. This preparation consists of an isolated membrane in the case of frog skin interposed between two lucite chambers and bathed on both sides by circulating physiological fluids. The experimental interest shown in the isolated

7

frog skin arose from its activity as a source of bioelectric current and potential brought about by its active transporting of sodium ion across the skin from the outside to the inside. This membrane transports sodium ion against both a concentration gradient and an electrochemical gradient. The transport is associated with electrical activity, since the current measured in microamperes is equivalent to the sodium transported as shown by radioisotope experiments (4). These phenomena are dependent on oxidative metabolism (5) and may be altered in magnitude by addition of carbon dioxide, drugs (6), and certain hormones (7,8). Skin from one side of the ventral midline of a frog served as a control, skin from the other side of the same animal prior to the assembly of the apparatus was irradiated with 3 cm. microwave radiation for from 10 to 20 minutes at 0.042 watts/cm<sup>2</sup> as indicated in Figure 5. The skin temperature averaged 30° C. with a brief maximum of 34° C. Those skins which transported most actively (as indicated by the control half) had their transport greatly reduced as a result of the 3 cm. microwave exposure; those skins which transported least actively had their transport mechanism inhibited slightly, if at all. In general, those skins which showed a high transport activity were "newer" skins in terms of the last molt, and perhaps their transport activity, being greater, was more sensitive to environmental stimuli.

The effect of heating the circulating ringers to 35° C. for 20 minutes is illustrated for both control and irradiated preparation. Evidently convective heat at this temperature stimulated but did not result in subsequent inhibition of transport during its application. The effect of posterior pituitary hormone (pitressin) is also illustra-

FIGURE 5

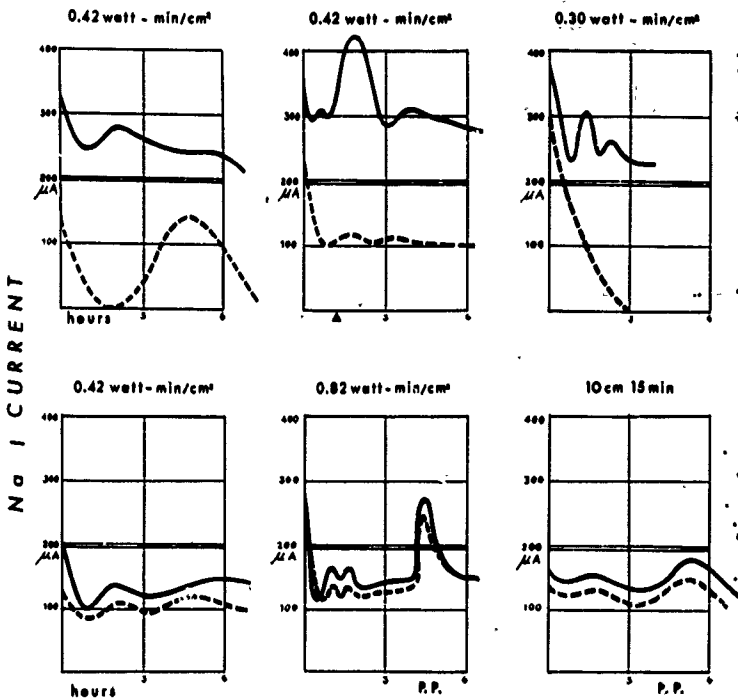

EFFECT OF 3 CM. MICROWAVES ON IRON TRANSPORT MECHANISMS OF FROG SKIN

ted which showed that the response to this hormone has not been altered between control and experimental skins.

More experiments of this nature are planned for the future in the hope of finding the mechanism inhibited by 3 cm. microwave radiation and in isolating the "protective" mechanism presumed present in the less active skins. Since the frog is poikilothermal it is planned to irradiate the isolated skins at low temperatures in order to isolate the role played by heat in observed microwave effects.

#### REFERENCES

1. Baus, R.: A Method of Measuring the Complex Dielectric Constant of High Loss Materials in the Range of Centimeter Waves. (Part of Annual Report, Contract Nonr-475(03), 1956).
2. Dureau, L.: On the Scattering of Electromagnetic Radiation by Spheres. (Part of Annual Report, Contract Nonr-475(03), 1958).
3. Nieset, R. T., et al.: Office of Naval Research Annual Progress Report, Contract Nonr-475(03), 1958.
4. H. H. Ussing and K. Zerhan: Active Transport of Sodium as the Source of Electric Current in the Short-Circuited Isolated Frog Skin. *Acta Physiol. Scand.* 36:300-318, 1956.
5. K. Zerhan: Oxygen Consumption and Active Sodium Transport in the Isolated and Short-Circuited Frog Skin. *Acta Physiol. Scand.* 36:300-318, 1956.
6. E. Schofeniels: Action Du 2-4 Dinitrophenol sur le Flux de Sodium a Travers la Peau de Grenouille. *Arch. Internat. de Physiol. et de Biochimie* 63:361-365, 1955.
7. F. A. Furhman and H. H. Ussing: A Characteristic Response of the Isolated Frog Skin Potential to Neurohypophysial Principles and Its Relation to the Transport of Sodium and Water. *J. Cell. and Comp. Physiol.* 38:109-130, 1951.
8. Koefoed-Johnsen, H. H. Ussing and K. Zerhan: The Origin of the Short-Circuit Current in the Adrenaline Stimulated Frog Skin. *Acta Physiol. Scand.* 27:38-48, 1952.

REVIEW OF THE WORK CONDUCTED AT THE UNIVERSITY OF MIAMI

by

Dr. M. L. Keplinger

A. INSTRUMENTATION

The studies at the University of Miami are conducted with a pulsed magnetron with a frequency of approximately 2400 mc and a very short wavelength of about 1.25 cm. Our peak power output is 40 kw but most of our animal experimentation and exposures have been conducted with an average level of about 20 watts. We have facilities for two separate operating units, two radar sets--one for acute exposures which will be varied every day, and another for chronic exposures.

The acute exposure chamber consists of a shielded plywood box 4' sq. by 3' high. Its entire inner surface is lined with microwave absorbent material (Eccosorb FRL 330). The floor surface is covered with fiberglass mat and polyester resin to prevent contamination and the scratching of animals. The waveguide of the microwave generator enters the acute box through one side horizontally near the top. It is terminated by a 90° bend and a 10db horn radiator which directs microwave energy downward onto the test subject. One side of this enclosure serves as a hinged door which when lowered completely shields the chamber, making it suitable for electroencephalography or other studies.

The chronic chamber consists of a room approximately 12' wide by 24' long by 8½' high. Its entire inner surface (floor, ceiling and walls) are lined with microwave absorbent material (Eccosorb

FR 330). It is air conditioned and temperature controlled. We are going to control humidity for animal exposures. For our chronic exposures we have a turntable which is 8' in diameter, set in the center of the room. It is powered by a  $\frac{1}{2}$  hp. electric motor and rotates at a speed of approximately 1 rpm. Six sector shaped cages which occupy the surface of the turntable provide enclosure space for the experimental animals. These cages are constructed of plywood and lined with microwave absorbent material (Eccosorb FRL 330). They are 4' deep, 3' high and their sides subtend an arc of 60°. The tops and fronts of these units are enclosed with corrugated 5/32" thick Plexiglas. The inner bottom surfaces are covered with fiberglass mat and polyester resin. Irradiation of the experimental subjects will take place through the corrugated Plexiglas.

#### B. ACUTE EXPOSURES

In order to observe immediate effects, a rat was first exposed close to the antenna (3.8 cm.) or 1 $\frac{1}{2}$ ". This is in the near field. At this distance, an animal died (a rat) in about 15 minutes (the range was 13 to 18 minutes). The distance was subsequently increased to 7.6 cm. (about 3") which is definitely out of the near field. The approximate lethal exposure time was then determined at different intervals from the antenna or at different power densities. Each time animals were exposed the interval was increased by a factor of approximately 50%. We determined an approximate lethal exposure time at that interval; then we went to another interval increasing the distance from the antenna approximately 2.5 cm., (Table 1), and then again determined the exposure time.

Table 1

The Acute Toxicity of Microwaves to the Rat

The rats weighted from 200 to 257 gm. They were equally distributed as to sex. The total body was exposed, except as indicated otherwise.

<u>No. of Rats Exposed</u>	<u>Distance from Antenna</u>		<u>Calculated Power Density</u> watts/cm. <sup>2</sup>	<u>Minimum Lethal Exposure Time</u> min.	<u>Period of Survival after Exposure</u> hours
	cm.	inches			
10	3.8	1.5	near zone	4	15
8*	7.6	3	0.26	43	0
11*	7.6	3	0.26	24	15
7	10.2	4	0.15	35	15
6	12.7	5	0.097	45	15
6	15.2	6	0.078	56	15
7	17.8	7	0.057	80	15
9	20.3	8	0.045	91	15
5	22.9	9	0.035	135	0
3	25.4	10	0.028	139	0
3	27.9	11	0.024	>450	Survived
2	30.5	12	0.020	>480	Survived

\* Head was exposed

\*\* Lumbar region was exposed

It is emphasized that the power densities (Table 1) are calculated values, not actual measurements of field strength, and that they are, therefore, subject to modification. Nevertheless, it is quite interesting that a power density of as little as 0.03 watts/cm.<sup>2</sup> (or possibly less) produced death in a rat. Please note that the minimum lethal exposure time increases as the distance is also increased.

The graph (Figure 1) was drawn to illustrate the relationship between the approximate lethal exposure time and distance from the antenna, that is, power density. The logarithm of time was plotted



Figure I

*THE ACUTE TOXICITY OF MICROWAVES*

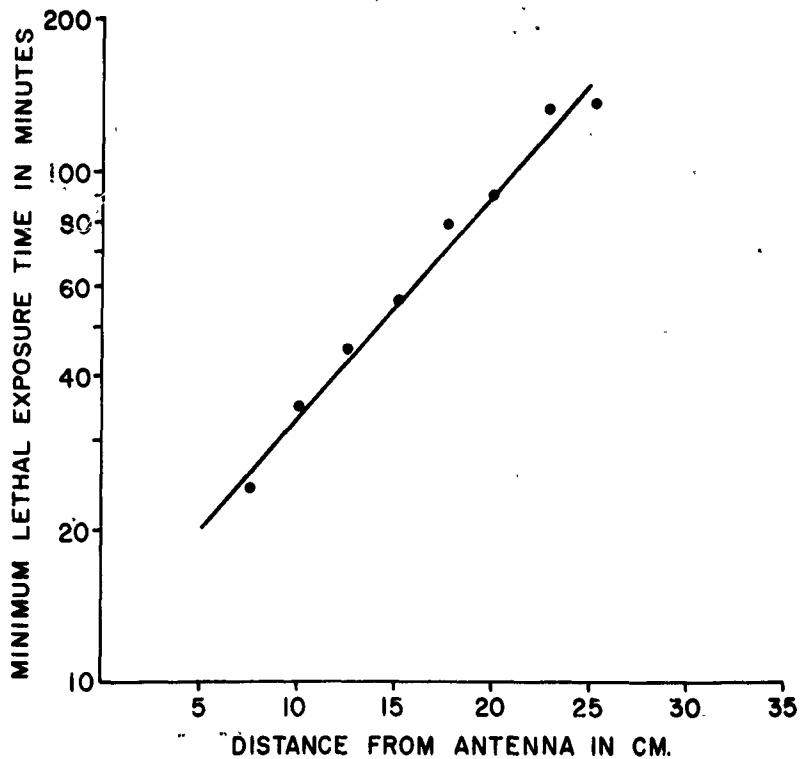

against distance. Even with biological variations such as are expected when small numbers of animals are used, there is practically a linear relationship between these two functions in the immediate far field where these studies were conducted. If the approximate lethal exposure time for the near field were included, it would fall well below the line. The power density is probably much greater in this zone.

More prolonged periods of exposure are in progress at 27.9 and 30.5 cm. The results are not complete; however, there is an indication that 30 cm. is close to the "threshold" distance or power density beyond which acutely lethal effects will apparently not occur in the rat.

Signs of Intoxication. Obvious signs of microwave effects were observed in rats exposed on the head at close range, that is, at a distance of 3.8 cm. from the antenna. The rat was immediately aware of some type of pain stimulus and tried to move to avoid it. There was squealing and struggling within 15 to 25 seconds. The ears were hyperemic at first, then turned dark in color. First, second and third degree burns were eventually produced on the skin directly in front of the antenna. The most conspicuous effect was stimulation of the central nervous system with muscle spasms, tremors and chronic convulsions. The tail stood up almost straight. This stimulation was so marked that it aroused a rat from deep surgical pentobarbital anesthesia. Periods of central stimulation alternated with periods of depression; however, the periods of depression grew shorter as exposure time increased.

When the rat was moved farther away from the antenna, about 3 inches or 7.6 cm. there was a similar CNS stimulation when the rat was exposed on the head, but when the lumbar region was exposed at this same distance, then central stimulation did not become apparent. It is also interesting that the approximate lethal exposure time for a rat exposed on the head at a distance of 7.6 cm. was 43 minutes, while it was 24 minutes for one exposed at the same distance in the lumbar region.

There was no cutaneous burning as the distance was increased to 10 cm. or greater. At 12 cm. or more, the obvious signs of microwave effects (tremors, etc.) were very slight, but redness of ears and nose was still produced.

We have taken rectal temperatures on these animals and there is a consistent rise at all power densities capable of inducing acute fatalities. However, the rate of temperature increase was slower as the distance became greater. This is illustrated in Table 2.

Table 2  
Effects of Exposure to Microwaves on the Rectal Temperature of the Rat

<u>Period of Exposure</u>		<u>Rectal Temp. Produced</u>
at <u>Distance of</u>		
<u>12.7 cm.</u>	<u>20.3 cm.</u>	<u>06</u>
0 min.	0 min.	37
- min.	18 min.	38
5 min.	30 min.	39
7.5 min.	60 min.	41
10 min.	120 min.	42
20 min.	180 min.	42.5
30 min.	240 min.	43

A rectal temperature of 43°C. appears to be quite critical for a rat exposed to these microwaves. If the temperature remained below 43°C., the animal survived; if it exceeded it, the rat died. We are doing other investigations to check into what this may mean.

### C. ELECTROENCEPHALOGRAPHIC STUDIES

Instrumentation. Recordings were made with a Glass Model IIIC electroencephalograph. No detectable interference was produced in the tracings by the radar beam when directly superimposed upon the recording electrodes.

Animals. Rabbits have been employed in the preliminary experimentation. These have been enclosed in a box shielding all of the body other than the head. The animal is placed in such a way that the plane describing the dorsal aspect of the head is perpendicular to the radar beam. Recordings have been variously made using silver surface electrodes fixed with collodion or by inserting bare wire electrodes subcutaneously. Recordings were made of frontal, occipital and parietal areas.

Results. In the recording shown (Figure 2), tracing A shows the activity which is normal surface pattern, recorded from a surface electrode in the parietal area. In tracing B, a marked increase in amplitude can be seen. This effect was produced after 3 min. exposure and at a distance (antenna to head) of 12.5 cm. This pattern continued for about one minute and was then followed by a period of slow activity shown in the first part of tracing C. After 5 min. exposure, there was a sudden onset of high amplitude high frequency activity of about 6 sec. duration which was accompanied by slight

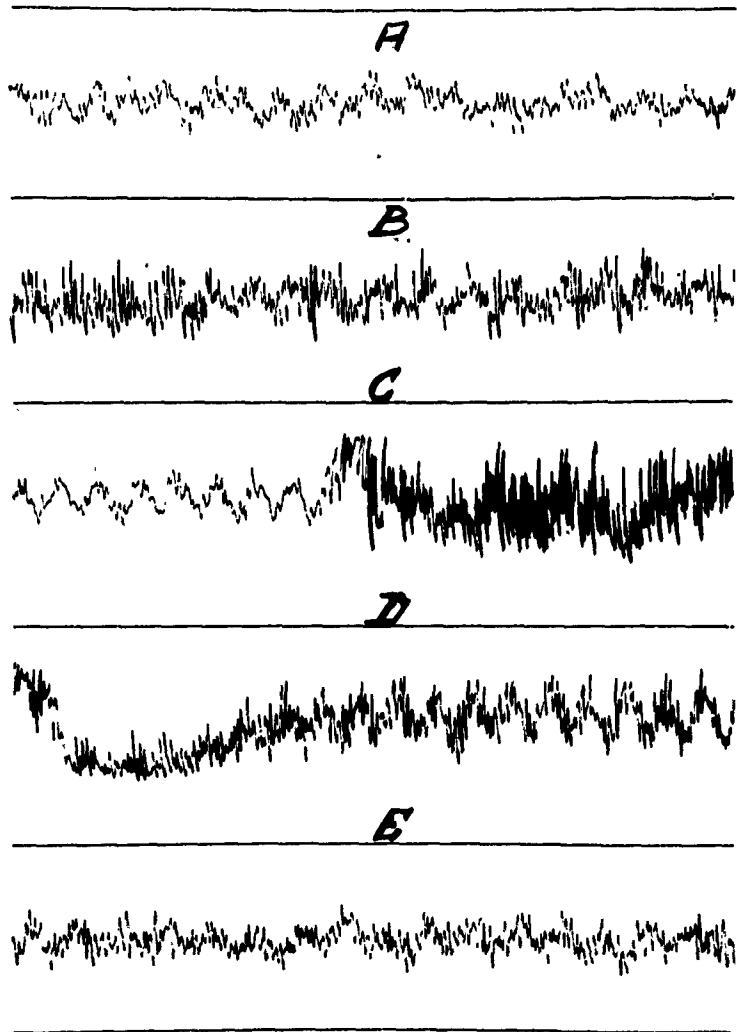

Fig. 2. Electroencephalograph Recordings of Rabbits Under Radiation

7

movement of the animal, (second part of section C). Immediately after this burst the frequency remained high (tracing D) and was similar to that seen earlier (tracing B). In spite of the continued exposure there was a gradual return to nearly control activity as shown in tracing E (seven minutes after the initial exposure). This sequence of occurrences was cyclic, recurring at 5-10 minute intervals. Discontinuance of radiation during periods of hyperactivity was followed almost immediately by a return to normal activity.

#### D. HEMATOLOGY

Rats exposed to microwave radiation have shown an increase in the number of erythrocytes and in the concentration of hemoglobin in tail blood examined immediately after an exposure. At the same time, there was a decrease in total leukocytes. A blood sample taken 16 to 18 hours after exposure showed a normal total red blood cell count the hemoglobin content, but a further decrease in the number of leukocytes (white cells). The polymorphonuclear leukocytes increased, the lymphocytes decreased. Again I would like to emphasize that this is preliminary work. We are not sure what this may mean. Recovery was not complete within one week, but was complete within two weeks. A second exposure again induced similar effects.

(Table 3.)

Notice the leukocytes column, which is the middle one, particularly in that the count fell immediately after exposure, at 16 hours. It was still not normal in about 8 days. It was practically normal in 14 days. After the second exposure it again fell not quite as far as before but this was a significant drop. And although

Table 3

## Effects of Exposure to Microwaves on the Hemopoietic System of the Rat

Rat was exposed for two 7.5-hour periods at a distance of 27.9 cm. or to 0.24 watts/cm<sup>2</sup>.

Time	Erythrocytes millions per cu. mm.	Hemoglobin gm./100 ml.	Leucocytes thousands per cu.mm.	Poly-		total number per cu.mm.
				Morpho- nuclear Cells	lymph- ocytes	
Before exposure	5.74	12.0	20.8	4.2	16.4	
Immediately after exposure	7.60	14.6	18.3	14.3	3.7	
16 hrs.	5.46	11.0	13.9	6.1	7.8	
8 days	6.14	12.9	16.3	3.7	11.7	
14 days after exposure	6.22	12.9	20.0	7.4	11.6	
Immediately after 2nd exposure	7.42	14.4	16.2	13.8	2.1	
16 hrs.	5.74	13.2	15.6	5.9	9.2	
6 days	5.66	13.6	17.3	2.9	14.0	

these are preliminary data we feel that this has some significance and we should go ahead and repeat this work.

E. EXPOSURE TO AN INFRARED HEAT LAMP

Since the microwaves caused an increase in body temperature, rats were exposed for comparison to heat from a different source. An infrared lamp (250 watts) was chosen for the source of heat. An animal was immobilized in the prone position and exposed, another rat was exposed in the same manner to microwaves.

These experiments were started quite recently and should therefore be considered as preliminary. The signs of local and systemic toxicity induced by the rays of the lamp were quite similar to those caused by microwaves. The heat lamp at close range also produced central nervous system stimulation, and post-mortem findings were similar to those produced by microwaves. (The CNS stimulation was apparent.)

Rats from which the hair had been closely clipped and controls (not clipped) were used to determine differences in penetration and dissipation of heat. From Table 4, the rather obvious observation was made that the "clipped" animal (in contrast to an animal with fur) had a shorter survival time under the infrared lamp, but a longer survival time when exposed to microwaves. It will be recalled that a rat exposed to radar invariably died when its rectal temperature reached 43°C. When the rectal temperature of a rat under the lamp reached 43°C., it survived for another 8 to 15 minutes, that is, until its rectal temperature reached 47°C.



Table 4  
Comparative Effects on Rats Following Exposure  
to  
an Infrared Heat Lamp and Microwaves

One rat was used for each experiment

<u>Type of Exposure</u>	<u>Distance between source of Radiation and Rat</u> cm.	<u>Minutes of Exposure Causing Death</u>	
		<u>Normal Skin</u>	<u>Skin Clipped Free of Fur</u>
Infrared	22.9	15	12
Infrared	44.4	30	17
Infrared	44.4	33	20
Microwaves	7.6	26	37
Microwaves	7.6	28	52

In another experiment, two rats (same sex and body weight) were used. One was exposed to infrared and the other to microwaves. A rectal thermometer was inserted into each animal and left to permit constant recording of the temperature. When a rectal temperature of 43°C. was reached, exposure was terminated. The "radar" rat died, while the "lamp" rat survived. The maximum temperature (of 43°C.) was reached at almost the same time in both rats. The marked difference was that the rectal temperature of the "lamp" (microwave) rat remained at 43°C. for 10 minutes before it started to fall. At death, which occurred in 12 minutes, the temperature was still 42.7°C. This to me indicated that we should do some more work along these lines.

F. GROSS POST-MORTEM FINDINGS (RATS)

Exposure of the head in the near field (at 5.3cm.) caused hyperemia with petechial and some diffuse hemorrhages in the subcutaneous tissues. The skin was discolored (greenish gray). Muscles of the head and neck (directly under the antenna) looked "cooked." The capillaries of the cerebral cortex and meninges were distended with blood and "leaking." In the lungs, there was marked congestion with hemorrhagic areas apparently caused by thrombic emboli. The heart was contracted and filled with blood clots.

Exposures of the lumbar region at a greater distance of 7.6cm caused no burning of the skin, but severe hyperemia and diffuse hemorrhages in the subcutaneous tissues. There was more damage to the major organs than when the head of the rat was exposed. The kidneys and adrenals were inflamed. The liver and spleen were

discolored on the dorsal surfaces (nearest to antenna). Again the lungs were markedly congested and hyperemic. The heart was well contracted and filled with thrombi. There was dilatation of the blood vessels, including capillaries, of the entire gastroenteric tract with diffuse hemorrhages in the mesentary, particularly in the region very close to the posterior abdominal wall.

As the distance from the antenna increased, the pathological changes were similar but less severe. For example, at 20 cm. the subcutaneous hyperemia was moderate, the kidneys slightly congested, the liver showed disseminated patches of discoloration and the lungs were moderately congested. The adrenals were still markedly inflamed. Slightly further (22.9cm.), there was only slight hyperemia in the dorsal subcutaneous tissue, moderate congestion in the lungs and slight discoloration of the liver and spleen. At 25 cm. and farther there was slight congestion in the lungs, and we think that there is some congestion in the adrenals.

#### G. PHARMACOLOGICAL STUDIES

Preliminary Studies - Subacute Exposures. Since the start of experimentation (March 3, 1958), two rats (one male and one female), six male mice and two chicks placed in a plexiglas box were exposed to microwaves. The bottom of the box was 30.5 cm. from the antenna ( $0.019 \text{ w/cm}^2$ ). Exposure time was approximately five hours per day for a maximum of twenty-four days (122 hours) over a period of 73 days and usually about five days a week. The power density is approximately 200ths of a watt per square cm.

The rats were exposed for a total of 122 hours. One chick died from a cause we thought to be unrelated to the experiment (31 hours total exposure) and the second was sacrificed after 71 hours of exposure because it had grown too large for the exposure chamber. Two additional chicks were exposed on 13 days (5 hrs/day) over a period of 16 days. (Baby bantam chicks are now being purchased. It is believed that they will be more desirable because of their smaller size). Three mice died during nights, two were sacrificed when found moribund. They had been exposed for 104 to 122 hours, respectively. One mouse is surviving at this time.

The signs of microwave effects observed during these preliminary repeated exposures include loss of voluntary muscular activity, and hyperemia of ears and nose (rats and mice). Loss of voluntary control was pronounced in one chick. It was not observed in the others. From time to time the rats also showed this loss of voluntary activity. The rectal body temperatures of rats and chicks (not taken in mice) increased from 0.5 to 0.75°C. during each five-hour period of exposure. The temperatures returned to normal during the following night. A few of the preliminary blood counts showed a reduction of total white blood cells (14.7 to 11.2 in a female rat, and 19.0 to 12.5 thousands/cu. mm. in the male) and an increase in total red blood cells in mice (4.5 to 7.3 millions/cu. mm). There were no gross pathological organ changes in chicks and mice.

#### H. VIRUS LABORATORY STUDIES

Application of Tissue Culture and Embryos. Preliminary experiments have been carried out in three types of biological systems:

1. HeLa Cells (cancer cells of human origin) growing in a monolayer on the surface of round tubes were exposed to radar following removal of growth medium. After exposure at several distances and for several time intervals, the medium was replaced and the cells returned to the incubator. Cell survival and growth was followed daily thereafter. Only cells exposed at a distance of 1" for 10 min. became destroyed. The other cells appeared to show no evidence of loss of viability. These results suggest that the generation of heat at the close distance was most likely responsible for cell death.

2. An experiment was carried out employing chick embryos. The exposures were done through open windows drilled on the side of the shell. Because of technical errors, only two embryos survived. These received radiation for 30 min. at a distance of 12".

This experiment was repeated on April 17. In this experiment, the portion of the shell over the natural air sac was removed and radiation administered through this opening at a distance of 6". Some eggs were left unopened. The exposures covered periods from 30 min. to 2 hours. The open eggs did not survive. Death was due to drying out of the membrane. All of the unopened eggs survived and the chicks hatched at the proper time.

A third experiment was done on May 15. Ten-day old chick embryos in groups of 2 were exposed at 5" for periods of 30, 60, 90, and 120 minutes. The exposure was done through the open shell at the air sac. Following exposure, the air sac was sealed with scotch tape and the eggs returned to the incubator. All eggs survived and hatched at the proper time.

3. HeLa cells were attached to gelform sponges and the sponges were placed in plastic petri dishes. Exposure was done through the lid of the plastic petri dish. The time intervals were 10, 20, 40, and 80 min., and the distance was 6" (0.075 watts/cm<sup>2</sup>). Following exposure, the sponges were placed in 1 ml. amounts of growth medium in round tubes. The outgrowth of cells from the gelfoam sponges was then determined daily by microscopic observation. Although quantitations were not done, the over-all impression was that fewer cells were obtained from the sponges radiated for 30 min. or 40 min. than those radiated for 10 min. or 20 min., or from the non-radiated controls.

The last experiment suggests that this method may have merit, and additional experiments will be carried out.

#### I. BIOCHEMICAL STUDIES

The Biochem Department has also done some preliminary determinations of aldolase in samples of rat blood serum.

A preliminary experiment was carried out in which a rat was exposed to high intensity radiation until moribund and blood then collected for analysis. No useful information was obtained because the blood sample became hemolyzed either as a result of the radiation exposure or from the mechanics of the handling. Again, I'm not sure we can rule out these things. Also, it appeared that the type of change in tissue composition we had in mind would more likely be the result of chronic exposure of lower intensity.

The next step, therefore, was to set up an experiment in which several rats were exposed for a period each day for several successive

days at an intensity which would produce a noticeable effect but would not be lethal. Accordingly, 4 young adult rats were exposed for a total of 21 hours. Approximately 40 hours after the last radiation exposure, the chest was opened under ether anesthesia (ether) and blood collected by heart puncture. Results of aldolase determinations on the samples of blood serum were:

(Figures represent aldolase units)

<u>Irradiated</u>	<u>Control</u>
35.0	45.0
27.5	46.0
37.5	47.5

Too much weight cannot be placed on the preliminary results of a small experiment like this. We did find that there was not a very large variation in the control volume.

One pertinent question immediately suggests itself.

Is this a valid difference? This can be answered, of course, by repeating the experiment on a larger number of animals. It is particularly important to know the normal variation in serum aldolase in the rat. The few results above would seem to indicate that normal values do not vary widely. There is an indication that there is perhaps some effect and that we should go ahead with this work.

#### CONCLUSIONS

Rats, mice, chicks, and rabbits were exposed to microwaves (frequency approximately 24,000 megacycles) for a single period of minutes to hours, and also repeatedly for five hours per day for a maximum of 24 days over a period of 73 days. Most of the experiments were of a preliminary nature. Nevertheless, it is believed that the following conclusions are justified at this time:

Acute exposure has resulted in:

(a) central stimulation as evidenced by tremors, augmented activity as recorded with an electroencephalograph and convulsions (rats, mice, rabbits).

(b) decrease in leukocytes, increase in erythrocytes (rat).

(c) A rectal body temperature of  $43^{\circ}\text{C}$ . appears to be critical (fatal) for the rat when exposed to microwaves. When exposed to infrared, the critical temperature was  $47^{\circ}\text{C}$ . As far as the rectal temperature was concerned, recovery from the effects of infrared rays became apparent immediately after cessation of exposure. This was not the case following exposure to microwaves.

(d) Exposure to microwaves and to an infrared heat lamp produced similar signs of central stimulation (tremors, convulsions). When rats (controls) and experimentals from which the fur had been removed by close clipping were compared, it was found that the period of survival was prolonged in "control rats" exposed to infrared, and in "rats without fur" when exposed to microwaves.

(e) Exposure by microwaves of the lumbar area of the rat produced death earlier than exposure of the head (other conditions kept constant).

(f) Marked congestion and hyperemia were the most consistent gross pathological changes noted whether exposure was directed toward the head or lumbar area of a rat.

In every animal which we have killed, we still have seen some type of low congestion, even though it is rather mild.



REVIEW OF THE WORK CONDUCTED AT UNIVERSITY OF CALIFORNIA

Effects of Microwave Irradiation on  
Internal Temperature and Viability in Mice

by

Baruch S. Jacobson and Charles Süsskind  
Donner Laboratory of Biophysics and Medical Physics and  
Division of Electrical Engineering  
University of California, Berkeley

The aid of S. B. Fraunzitz in carrying out the measurements is gratefully acknowledged, as is the support of the U. S. Air Force under Contract AF 41 (657)-114, monitored by the Air Research and Development Command (RADC).

It has long been known that the temperature at certain internal sites in warm-blooded animals is highly independent of the ambient temperature. The problem of thermal balance has been the subject of numerous reviews<sup>1,2</sup>. Although several mechanisms are known to be involved, analysis of the overall thermoregulatory process is rendered somewhat difficult by the lack of data on subjects in thermal disequilibrium. Such data can be obtained by the use of microwave beams.

PROCEDURES

Swiss Albino mice weighing approximately 35 grams were irradiated with 3 cm radiation, using an Air Force AN/TPS-10D radar transmitter. The mice were exposed, over the entire ventral surface, to radiation fluxes which varied between 0.05 and 0.5 watts/cm<sup>2</sup>. The techniques employed have been described in detail.<sup>3</sup> Temperatures were recorded using a thermistor inserted rectally.

## RESULTS

### A. Experimental

The temperature of the mouse rises at a rate which is, on the average, proportional to the power density to which the mouse is exposed, except that at low power density, the rate of temperature rise decreases after a few minutes. Death occurs if a critical temperature, about  $44.1^{\circ}\text{C}$ , is exceeded. This temperature is  $6.7^{\circ}$  above the average normal temperature. In consequence, the average time of exposure necessary to produce an average temperature increment of  $6.7^{\circ}$  represents and  $\text{LD}_{50}$  (50 per cent lethal dose), as shown by survival studies.

Figure 1 shows the result of  $\text{LD}_{50}$  measurements at various power densities. None of these differs appreciably from the  $6.7^{\circ}$ -temperature-rise dose, after adjustment is made for a slight delay in thermistor response at the highest power densities. Figure 2 shows the temperature rise at various power densities as a function of the cumulative energy flux incident, i.e., of the product of the exposure time and the power. The mean of several individual recordings is plotted at each power density.

### B. Theoretical Considerations

During the initial 2 or 3 minutes of irradiation, the increase in temperature is nearly proportional to the amount of energy absorbed, regardless of the power density. If irradiation is continued, the temperature rises more slowly. Eventually, a plateau is reached, whose height appears to be directly related to the power density. Although this plateau has been shown only at the lower power densities, it must

occur at any finite power density. These observations can be explained if it is assumed that the animal is being heated and cooled simultaneously, so that

$$\frac{dT}{dt} = aP \quad - \quad b(T-T_0) \quad (1)$$

Heating Term                      Cooling Term

which yields, upon integration,

$$T - T_0 = a P t \left( \frac{1 - e^{-bt}}{bt} \right) \quad (2)$$

where  $P$  is power density,  $T$  is temperature,  $T_0$  is initial temperature,  $t$  is time and  $a$  and  $b$  are constants. The coefficient  $a$  is the product of the absorption coefficient of the mouse and the area it presents to the beam, divided by the product of its heat capacity and its mass. The value of  $b$  depends upon physiological, as well as physical parameters.

To produce any given temperature increase  $T_x$ , there is a minimum power  $P_x$  necessary, given by

$$P_x = \frac{b T_x}{a}$$

When  $P < P_x$ , the temperature  $T_0 + T_x$  will never be reached. When  $P = P_x$ , the steady-state temperature will be  $T_0 + T_x$ . When  $P > P_x$ , the time required to achieve a temperature of  $T_0 + T_x$  is given (solving Equation 2) by

$$t_x = \frac{1}{b} \ln \left( \frac{P}{P - P_x} \right) \quad (3)$$

For  $T_x = 6.7$ , the  $LD_{50}$  value, a reasonably good fit to the observed values of the  $LD_{50}$  (in terms of time) at various power densities is

obtained, (Fig. 1) within the limits of experimental error, by using:

$$P_x = 0.09 \text{ watt/cm}^2$$

$$a = 7.41 \text{ deg/min}$$

$$b = .0995 \text{ min}^{-1}$$

If this treatment is valid, the plot of Equation (2) using the above values of a and b, should closely resemble the experimental temperature rise curves. Perhaps most revealing is the plot of temperature rise as a function of energy density. For this purpose, Equation (2) can be modified to read:

$$T - T_0 = a E \left( \frac{1 - e^{-(b/P)E}}{(b/P)E} \right) \quad (4)$$

This equation is plotted in Figure 3. The factor in the parentheses approaches unity for small values of E or for large values of P. This factor may be regarded as the cooling factor, since it drops out for  $b=0$ . The graphs show that the agreement between the calculated and the experimental curves is qualitatively rather good, although the calculated curves show somewhat more spread at higher energy densities. Initially, there is a slight lag in the experimental curves because of the delay involved in distributing the heat throughout the body, which has not been considered in formulating the theory.

Apart from the initial lag, it is reasonable to suppose that appropriate modification of the cooling term in Equation (1) will result in an even better correspondence between the theoretical and the experimental curves.

From the present equation, the "permissible" dose of  $0.01 \text{ W/cm}^2$

will produce a maximum temperature rise of  $0.1^{\circ}\text{C}$  in mice measured rectally. Greater temperature changes might occur elsewhere.

While the above analysis does not completely describe the process of heat exchange in the mouse, it indicates a possible approach to the problem. It is hoped that further experiments will define the cooling term in Equation (1) more precisely. Information regarding the manner in which the rate of heat loss varies with temperature should facilitate the evaluation of the roles of the various mechanisms<sup>1</sup> known to be involved in heat dissipation.

Radiation at somewhat longer wavelengths would be absorbed more nearly uniformly,<sup>4</sup> permitting more precise analysis of the temperature changes. Detailed investigation of the cooling rates after termination of irradiation is contemplated. From these, it is hoped, more information about the dynamics of the cooling process may be obtained.

#### SUMMARY

The effects of 3-cm waves on the rectal temperatures of mice have been studied. The changes observed can be accounted for by calorimetric considerations. It is suggested that the temperature dependence of the heat-loss processes be studied with microwaves, in the hope of obtaining information about thermal homeostasis, information which is undoubtedly relevant to the problem of establishing tolerance doses for radar-frequency radiation.

#### REFERENCES

1. A. B. Hertzman. Heat and Cold. Ann. Rev. Physiol. 17: 79-106 (1955).
2. F. E. J. Fry. Temperature Compensation. Ann. Rev. Physiol. 20: 207-224 (1958).
3. C. Süsskind et al. Biological Effects of Microwave Radiation. Annual Scientific Report, Univ. of Calif. Inst. Eng'g. Research, Ser. 60 (205), June 30, 1958.
4. H. P. Schwan and K. Li. Hazards Due to Total Body Irradiation by Radar. Proc. I.R.E. 44: 1572-1581 (1956).

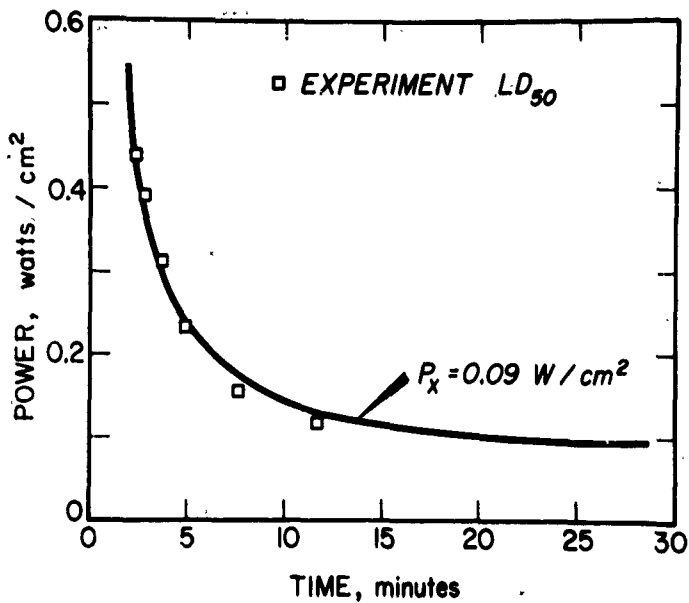
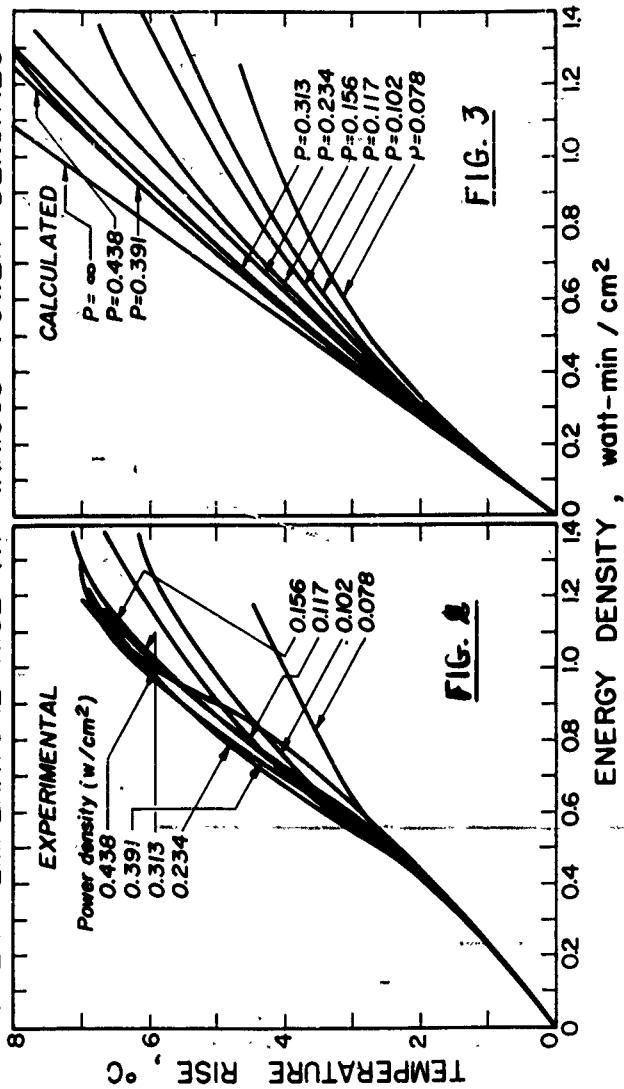

Figure 1

COMPARISON OF ENERGY DENSITIES NEEDED TO ACHIEVE A GIVEN TEMPERATURE RISE AT VARIOUS POWER DENSITIES





REVIEW OF THE WORK CONDUCTED AT STATE UNIVERSITY  
OF IOWA

by

Charles J. Imig, Ph.D., State University of Iowa  
Gordon W. Searle, M.D., State University of Iowa

For a period of time after World War II (1946-1949) our laboratory in the Department of Physiology at the State University of Iowa was engaged in research concerned with the biologic effects of the then relatively uninvestigated region of the electromagnetic spectrum known as microwaves.

Although many studies were conducted in these early investigations at Iowa, I would like to review briefly the findings of only a few which contribute directly as background information for our present series of investigations.

Certain biologic hazards were demonstrated in these early experiments. Whole body exposure to high-intensity outputs of microwaves for only a few seconds were found to be lethal to many species of laboratory animals. Exposure of limited areas of the body to relatively lower energy outputs of microwave energy resulted in local tissue damage.

In one series of experiments it was found that a direct single exposure of rabbit eyes to 12 cm. microwaves at a 5-centimeter distance for 15 minutes with 100 watts of power output resulted in the formation of cataract-like lesions in the lens of the eyes after a delay of 3 to 9 days. A series of repeated exposures to a smaller energy output of this frequency of electromagnetic waves resulted in

the formation of cataracts after delays ranging from 2 to 42 days. These opacities varied from small posterior polar masses to almost complete opacifications of the lenses. A relationship between the amount and duration of induced temperature increase in the lens and the frequency of cataract formation was noted. Induced lenticular temperatures of approximately 55° C. and above during a single exposure resulted in opacities while temperatures below 55° C. did not result in cataract formation.

A series of at least three separate exposures for 10 minutes duration at 5 cm. distance, raising the posterior lenticular temperature to an estimated 52° C. showed lens changes in 15 days. A single exposure of this duration and intensity resulted in no damage to the lens. When induced temperature gradients in excised eyes of beef were plotted, it was found that the point of maximum temperature agreed well with the site of damage which was found in the eyes of living animals subjected to irradiation. (Figure 1).

In another series of experiments the effects of microwave energy upon the testes of adult rats were studied. In these experiments the testes were irradiated with 12 cm. microwaves so as to increase the temperature of central areas of the gland. A single 10-minute exposure caused testicular damage at a temperature of only 35° C. Infra-red exposures resulted in degeneration only when the temperature was maintained for 10 minutes at approximately 40° C. or above. The testicular damage resulting from microwave irradiation resembled that seen in burn necrosis. (Figures 2, 3 and 4).

In other experiments in which limited areas of the body such as

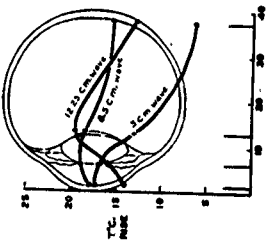
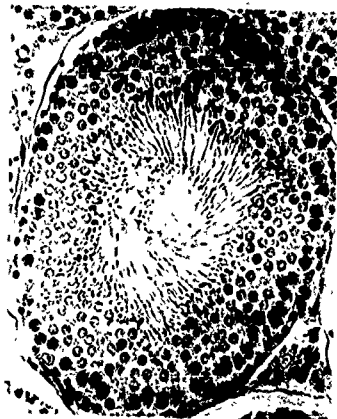
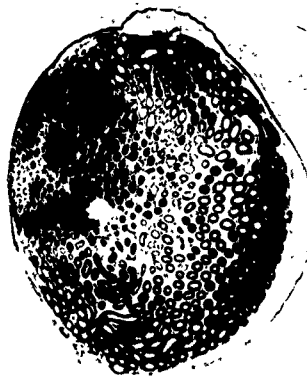

FIG. 3

Diagrammatic structure in red cells induced by administration of DMSO, 0.5 and 3 ml/kg



the abdomen were irradiated with relatively lower energy outputs of microwaves, it was found that the temperatures of visceral organs were markedly elevated whereas the oral and rectal temperatures remained within normal limits. This marked increase in temperature was found to be particularly true for hollow viscera such as the stomach, intestine, gall bladder, and urinary bladder where relatively avascular conditions prevail. (Table I).

Table I

CHANGES OF TEMPERATURE IN VARIOUS AREAS OF THE ANESTHETIZED RABBIT DURING IRRADIATION WITH 12-CENTIMETER ELECTROMAGNETIC WAVES

Region	Time in Minutes from Onset of Irradiation					
	1	2	3	10	20	30
	Temperature change in degrees centigrade					
Ileum	+4.2	--	+14.4	+29.5	+38.5	+42.9
Stomach	+1.8	+3.4	+5.4	--	+19.2	+23.1
Gall bladder	--	+0.1	+0.3	+1.8	+4.0	+6.3
Urinary bladder	+1.3	+2.1	+3.0	+5.6	--	+9.7
Rectal	+0.1	--	-0.1	+0.2	--	+0.8
Oral	-0.2	--	-0.2	-0.5	-0.9	-1.2

These earlier studies suggest that severe and injurious temperature increases may be induced in certain organs of the body (such as the eye and contents of hollow viscera such as the stomach, gall bladder, intestine, etc.) from microwave irradiation. These regions of the body are relatively avascular and therefore are not as well equipped for regulating their temperature by means of changes in blood flow as other more vascular regions of the body.

It was suggested that local heating of the contents of hollow viscera might cause functional and/or anatomic damage either to the organ in question or to adjacent tissue.

The current series of experiments being conducted at Iowa are concerned with an investigation of the hyperthermic effects of microwave radiation upon relatively avascular hollow viscera.

In one series of experiments the temperatures induced in the gall bladder, stomach, small intestine and liver of dogs were measured following local irradiation of the abdomen. The source of microwave radiation was a 12½ cm. microwave Raytheon generator. The "C" (or angle) director was placed 5 cm. distance over the abdomen. The output of the generator was regulated (during the exposure period) so as to maintain the skin temperature just below that which would cause burning of the skin. In preliminary experiments it was found that the skin temperature could not be increased over 42.5° C. for extended periods of time without damage resulting. The duration of exposure was 2½ hours. Temperature measurements in the various visceral organs and surface of the skin were obtained by means of thermocouples every 20 minutes with the generator turned off. The results of these experiments showed that the greatest increase in temperature in each of the visceral tissues studied occurred during the first 20 minutes of exposure. The highest mean temperature attained occurred at the end of the 2½ hour exposure. The highest temperatures attained were as follows:

Liver	= 41.1° C.
Gall bladder	= 41.1° C.
Intestine	= 41.8° C.
Stomach	= 41.8° C.

Considerably greater temperature increases were measured in the hollow visceral organs of rabbits than were found in the studies on dogs. The difference in animal size was considered to be the reason. In order to test this hypothesis large dogs, small dogs and a rabbit were all irradiated similarly, i.e., the abdomen was irradiated for 2½ hours with 12 cm. microwaves. The output of the generator was regulated to maintain the skin temperature at approximately 42° C. -- just below the heat damaging threshold. Temperatures were measured in various visceral organs during the exposure. The data collected are shown on the next series of figures (5, 6, 7, 8, 9).

Experiments were also conducted on larger dogs, smaller dogs and rabbits in which the output of the generator was maintained at 63 watts during the entire 2½ hour exposure. This exposure pattern resulted in severe burning of the skin in both the rabbit and smaller dog. Minor skin damage was evidenced in the larger dogs. The data are shown on the follow figures (10, 11, 12, 13, 14). These studies illustrate the importance of considering body size in defining dosages of microwave energy. It appears that the relative volume of the animal which is actually presented to the field of irradiation may play an important role in the ability of the animal to dissipate or distribute the absorbed heat to cooler parts of the body. When irradiating smaller animals, a much larger proportion of the total body volume would be absorbing the heat than would result from the irradiation of larger animals. Another important factor in the degree of temperature attained in animals studied would seem to be related to the distance that the organs or tissue lie from the source of the



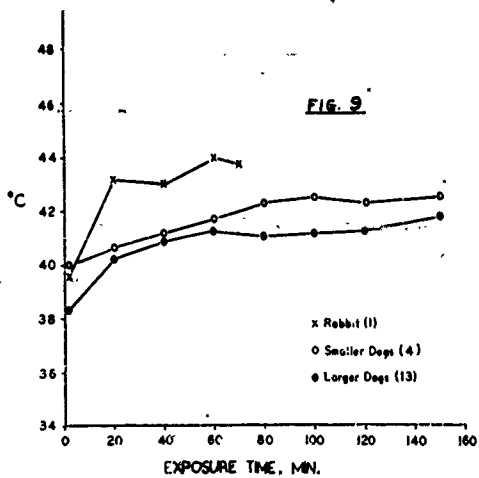
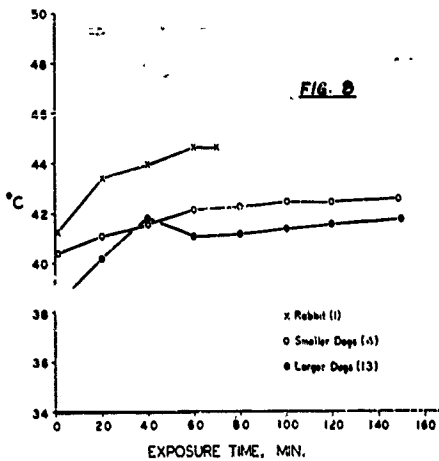



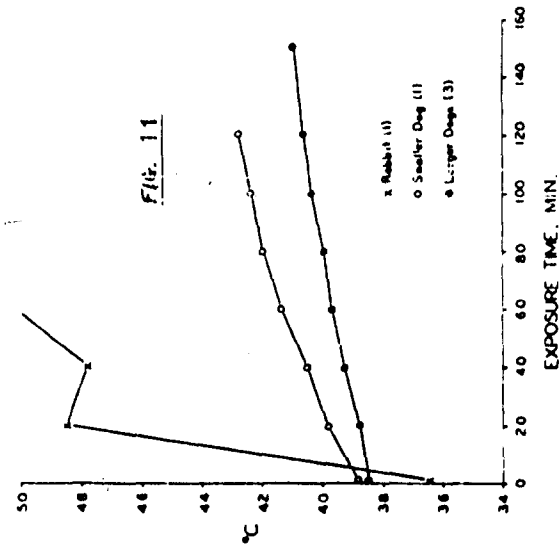

Temperature measurements obtained on abdominal skin (10); in gall bladder (11); in liver (12); in stomach (15); and in small intestine (14) during irradiation of the abdomen with 12.25 cm microwaves. (Generator output was held constant at 65 watts.)

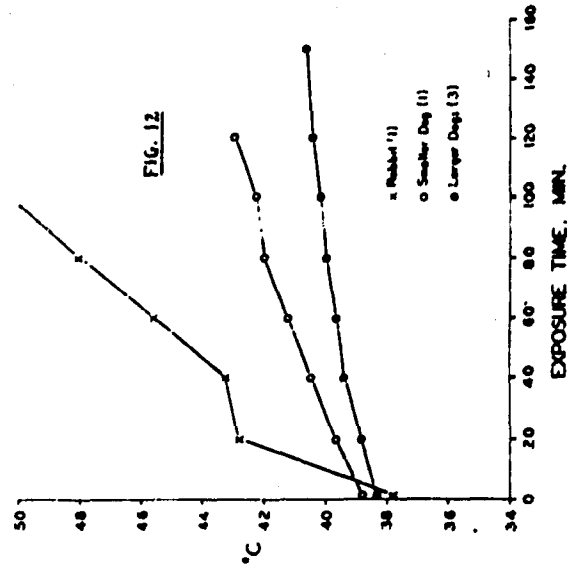
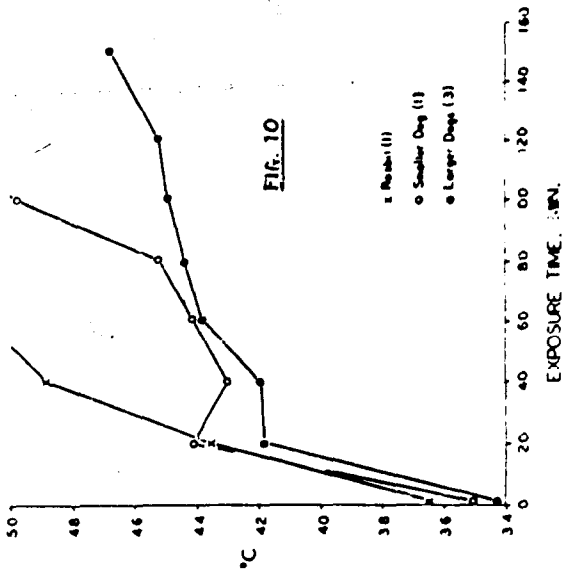

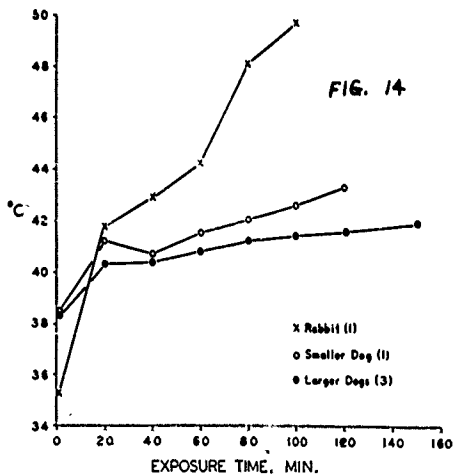
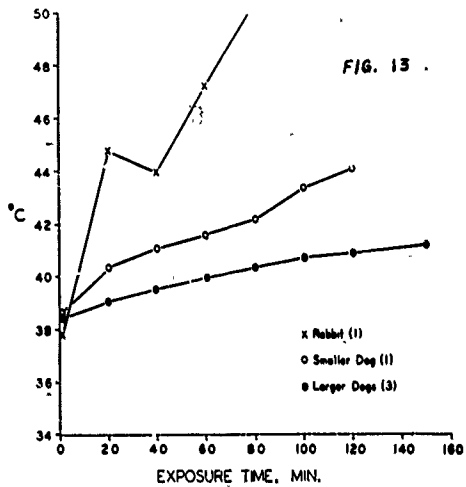

radiations. Thus, in small animals such as the rabbit, the liver would be closer to the source than would the liver of a large dog or human, even though the skin to director distance was the same in each case.

Another series of experiments have been conducted in which the effect of 12 cm. microwave exposures on liver function was determined. Although anatomic damage was not evidenced in the hollow visceral organs or in the liver, functional impairment might occur. In these studies liver function was measured by means of BSP determinations in 3 dogs following exposure of the abdomen to 12½ cm. microwave radiation during which the skin temperature was maintained at or near the damaging threshold. Each animal received 15 separate 2½ hour exposures. Exposures were made on each animal every other day (except weekends). Liver function was measured 24 hours after each exposure. No changes in liver function were measured following any of these maximal tolerable exposures,

The final series of experiments to be reported are concerned with the measurement of temperatures induced in the fourth ventricle of the brain along with observations of gross motor activities of dogs resulting from exposures of the head with 12 cm. microwaves. In these experiments the head of anesthetized dogs were exposed for 2½ hours with "C" or angle director of a Raytheon generator at a distance of 5 cm. The output of the generator was regulated so as to maintain the skin temperature at approximately just below 42° C. This was considered the maximum tolerable dosage. Temperatures were measured in each of 6 dogs in the 4th ventricle, rectum and

surface of the skin on the head. The data collected are shown on the next figure (15). Six other animals were irradiated with this exposure pattern on each of five successive days. Temperatures were measured only in the rectum and on the surface of the skin. These animals were observed daily during the exposure series and for 3 weeks following the last exposure. Observations were made of muscle coordination, gait and reflexes. No gross abnormalities in their behavior pattern were noted. Upon sacrificing the animals the brains were examined for gross lesions. None were observable. Additional experiments are being carried out on unanesthetized dogs as immediate or short term C.N.S. effects can only be observed in unanesthetized animals.

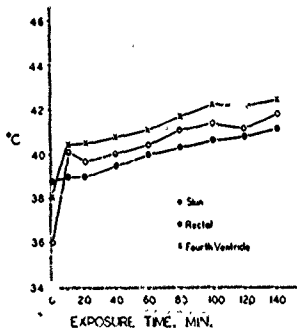

FIGURE 15

-- Temperature measurements obtained during irradiation of the heads of dogs with 12.25-cm.-microwaves. (Output of generator during exposure was regulated so as to maintain temperature of the skin on the head just at the thermal damage level.)

Summary:

The thermogenic effects of microwave irradiation depend upon a balance between (a) the heat produced by the absorption of the microwave energy and (b) the capacity of a tissue or an organism to dissipate its excess heat.

It is important to know what proportion of the total body is being subjected to radiations in any experiment, i.e., exposure of 1 sq. cm. of the chest of a rat to a given power output of microwave energy can be expected to produce quantitatively much greater thermogenic effects than one would find upon irradiating the chest of a dog with 1 sq. cm. exposure. It would be helpful if in communications and publications the pattern of irradiation be correlated with total body area, weight, organ mass, depth, etc. if comparisons are to be made of work done in different laboratories.

The earlier findings showed that certain areas of the body were more vulnerable to the effects of microwave radiation than others.

It was found that relatively avascular areas exhibited greater rises in temperature; and, as a consequence, there was more tissue damage than was found in more highly vascular areas. This was especially true for hollow viscera, eye and testicle. The latter organ is also more susceptible to damage by hyperthermia than other tissue.

The current investigations are designed to answer the question as to what functional and structural damages might result from hyperthermia developed in the gall bladder and in the ventricles of the brain. So far the studies have been concerned with the effects of microwaves applied in relatively low intensities and for relatively

long periods of time. The effects of repeated exposures have been observed. The exposures have been monitored so as to avoid overt surface burns. Investigations also underway involve a study of the effects of exposing dogs to much greater energy outputs of 3 and 10 cm. waves.

In our studies so far no effects of microwave energy have been encountered which cannot be accounted for on the basis of thermogenic effects.

REPORT ON THE WORK AT SOUTHWEST RESEARCH INSTITUTE  
ON THE USE OF ELECTRON PARAMAGNETIC RESONANCE TO  
EVALUATE THE CHEMICAL AND/OR PHYSICAL CHANGES  
IN THE LENSES OF EYES IRRADIATED BY MICROWAVES.

By

William L. Rollwitz, Southwest Research Institute

The main objective of the program at Southwest Research Institute is to determine the feasibility of using the technique of Electron Paramagnetic Resonance (EPR) to study the chemical and/or physical changes in the lens of the rabbit eye when it is irradiated with microwave energy. This discussion will give a brief explanation of the technique, will present representative illustrations of previous work at SWRI in other allied fields, will discuss the present program, and will present the work accomplished to date.

A. THE EPR TECHNIQUE

Electron Paramagnetic Resonance is one of the techniques of the group called absorption spectroscopy and more particularly of the sub group called Radio Frequency Spectroscopy. Since all of the group in absorption Spectroscopy are involved in the measure of the energy required to cause transitions between two or more energy states of the particles involved, EPR is no exception. When a free or unpaired electron is placed in a magnetic field of strength,  $H$ , there is established two energy levels for those electrons  $W_1$  and  $W_2$  because of the interaction between the magnetic field of the free electron and the external magnetic field, and because of the angular momentum of the electron. Therefore, if a quantum of energy,  $h\nu$ , equal to the difference between the two energy states is applied to the system,

transitions will result between the two energy levels. Those in the lower level will be stimulated to the higher level and those in the higher level will, therefore, be induced to go to the lower level. Since the probability of a transition in each direction is the same, and because there are more electrons in the lower energy level than in the higher energy level, there will be a net absorption of energy by the system from the applied energy. This relation can be written then to obtain the frequency of the energy to be applied as,

$$v = \frac{gBH}{h}$$

where  $v$  = frequency

$g$  = Spectroscopic Splitting factor

$B$  = Magnetic moment of the free electron

$H$  = Strength of the Applied Magnetic field.

$h$  = Planck's constant

The value of  $\frac{g\mu_B}{h}$  for a single free electron in a vacuum would be 2.8 megacycles per gauss. Therefore, in a magnetic field of 3300 gauss, the frequency of the applied energy would need to be approximately 9300 megacycles. Equation (1) does not show that there is any finite width to the absorption signal. This is because it implies that each free electron in the system "sees" the same magnetic field. However, since each neighboring particle has a magnetic field, and since the free electrons are held in the system by some type of bond or orbit, only certain groups of free electrons at certain positions or orbit orientations will "see" the same magnetic field. Therefore, if we sweep the applied magnetic field through the total range of magnetic



fields expected at the particles to make equation (1) an equality, the resultant curve will be of finite width. Such a curve for the stable free electrons in a sample of Diphenyl-Bicryl-Hyclrazyl is shown in Figure 1. This curve is the derivative of the actual absorption curve which was a shape like a gaussian or lorentzian curve. The derivative curve results from the techniques required to increase the signal - to - noise ratio and is used by us on all curves, even those like Figure 1 wherein the absorption curve could be viewed with good signal - to - noise ratio.

All that is required then to observe the curve of the absorbed energy as a function of magnetic field is to subject the sample simultaneously to radio frequency energy and a magnetic field according to equation 1, and measure the absorbed radio frequency energy. We use a klystron to supply the radio frequency energy, a cavity in which the sample is placed to measure the absorbed energy, and a 4-inch electro-magnet to supply the magnetic field as shown in Figure 2.

#### B. PREVIOUS WORK

In this discussion we will use the terms "Free Radical" and "Free Electron" interchangeably since we define a "Free Radical" as a molecule with a free or unpaired electron. We have found that the shape of the absorption curve is dependent upon how this free electron or free radical is made. Figure 3 shows two species of free radical from the same material, one made by heat and one by ionizing radiation. The apparent difference, but not the reason for the difference, is obvious.

Most free radicals are very short lived and exist for only a few seconds at most. The life can be extended if the temperature is reduced. Some species of free radical will decay rapidly at one temperature

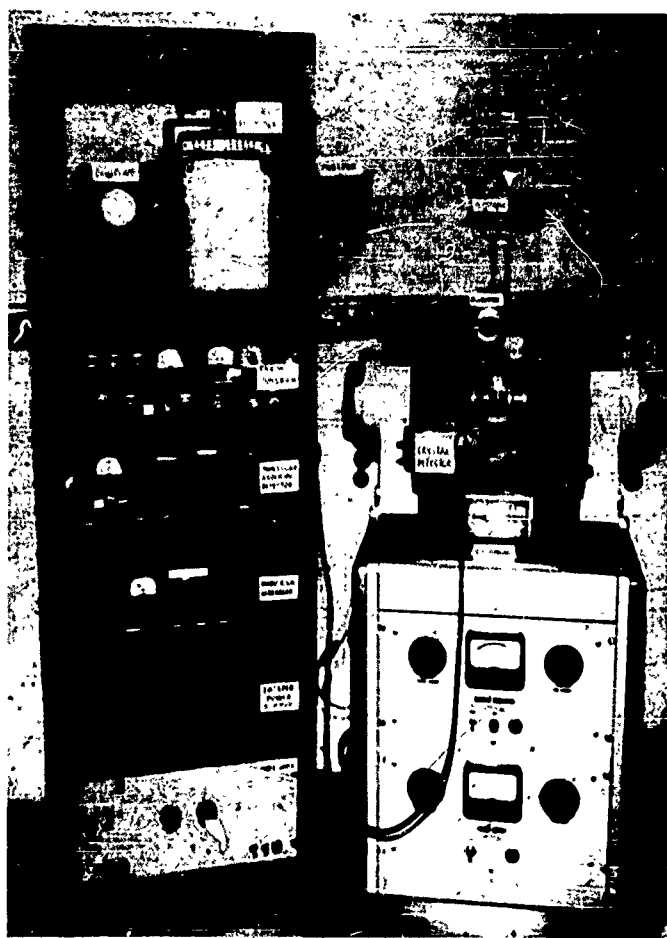

Figure 2

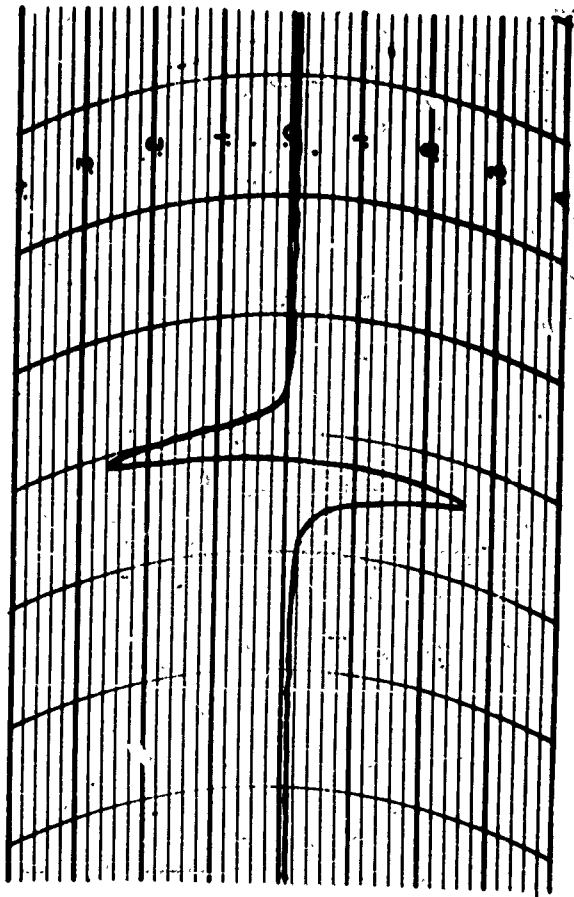

Figure 1 TYPICAL DERIVATIVE-TYPE SIGNAL FROM DIFFERENTIAL-PICKOFF  
HYDRAZYL.

but will be stable at a lower temperature. An absorption curve for one stable at room temperature is the one found in roasted coffee shown in Figure 4. This free radical can also be found in the brew made from the roasted coffee, since there may be more than one species of free radical when a material is irradiated with ionizing radiation. To study each of these, independently, it is necessary to determine the temperatures at which the various species are stable and decay. An example of such a study is given in Figure 5 for albumin. Curve A contains all of the free radical species whereas curve B contains only one. It is therefore a simple matter to subtract the two and obtain the shape of the curve for the second. Figure 6 shows a similar series for milk solids. The reverse can also be done as shown in Figure 7 for tristearin.

By a determination from the amplitudes of these curves the concentration of free radicals can be obtained. By a study of the shape of the curve for each species the position of the free electron in the molecule can be obtained. Since the free electron is free and is not well shielded, it is very sensitive to both chemical and/or physical changes in the material. The effect of a slight change in the structure of different samples of egg albumin has been shown as an increase in the two out of phase bumps on the curve of Figure 5.

#### C. THE PRESENT PROGRAM

As stated previously, our objective in this program is to determine the feasibility of using this technique to study the chemical and/or physical changes caused by microwave radiation. Col. Knauf wisely selected the rabbit lens as the material to be studied. The

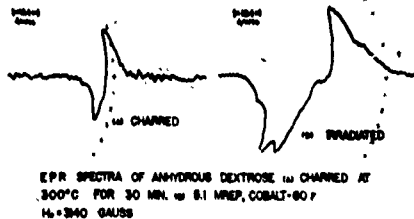

FIG. 3.

RECORDED EPR ABSORPTION DERIVATIVE CURVE OF ROASTED, VACUUM PACKED COFFEE

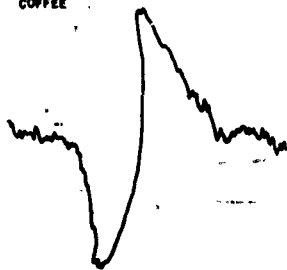
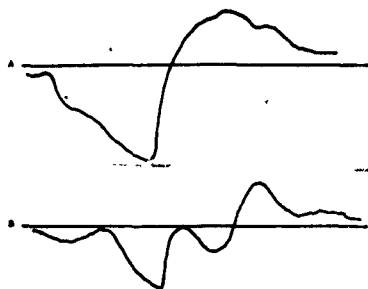
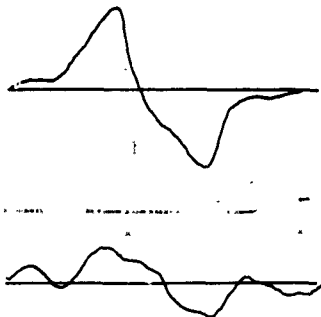

FIG. 4



EPR spectra of irradiated albumin at  $-175^{\circ}\text{C}$  (1.7 Mrad)  
 A. Immediately after irradiation at  $-175^{\circ}\text{C}$   
 B. After irradiation at  $-156^{\circ}\text{C}$  and 5 minutes annealing at  $-70^{\circ}\text{C}$

FIG. 5



EPR SPECTRA OF IRRADIATED MILK SOLIDS

FIG. 6

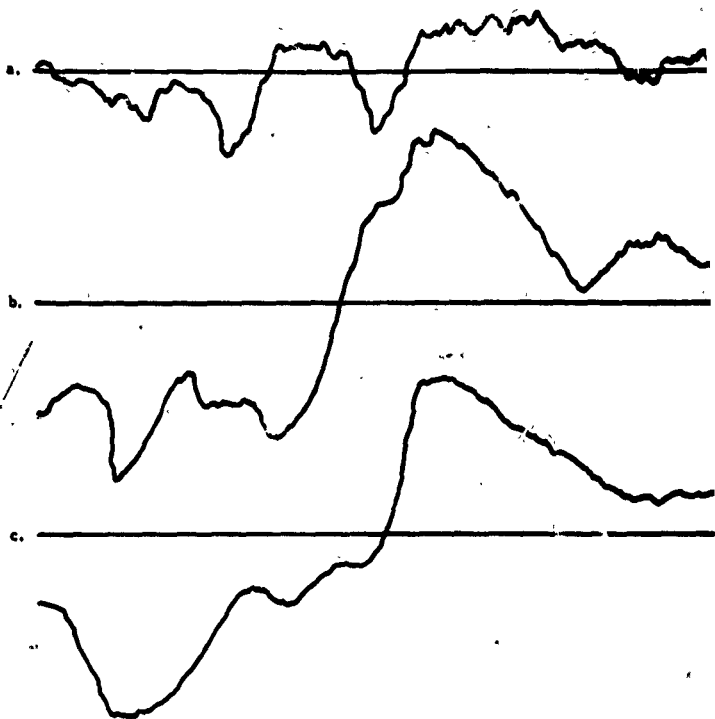

**EPR spectra of tristearin irradiated and examined at different temperatures.**

- (a) Dose,  $2.7 \times 10^6$  rep; irradiated and examined at room temperature.  
 (b) Dose,  $1.5 \times 10^6$  rep; irradiated at  $-78^\circ\text{C}$  and examined at  $-65^\circ\text{C}$ .  
 (c) Dose,  $1.8 \times 10^6$  rep; irradiated and examined at liquid nitrogen temperature.

Figure 7

rabbits will be irradiated by Dr. Carpenter and his group at Tufts and then sent to us. We will sacrifice the animals, remove the lenses and immediately cool them to  $-196^{\circ}$  C. Since the life of most free radicals is so very short, we do not expect to obtain any, but they will be checked.

We will then put in some free electrons as observers that can be used to give information about the chemical and/or physical changes produced by microwaves. Since only one eye of each rabbit will be irradiated with microwaves, we will have a control for comparison. We will produce these observer free radicals with a small cylindrical Cobalt 60 source of 160 curies giving a dose rate of  $3.4 \times 10^5$  rep per hour in a volume of 30 milliliters, or a soft x-ray unit producing  $50 \times 10^6$  rep per hour in a thin sample of  $1 \text{ cm}^2$  cross-sectional area, 2 cms. from the target.

We will observe the free radicals produced in the above manner in both the microwave irradiated eye lens and in the unirradiated lens and determine their differences and their decay characteristics. This procedure will be followed four times as soon after irradiation as possible, at different times during the maturing time, and after the onset of the opacity.

#### D. WORK ACCOMPLISHED TO DATE

Because of the interference of a high priority government program, we have not really started our program, scheduled to begin the latter part of July. We have, however, made some preliminary measurements on an unirradiated lens from a rabbit of the same species as employed by the Tufts group. The curve obtained is shown in Figure 8. This curve

shows only one predominant species of free radical. There is evidence of a other, but its concentration is too low to permit a measurement with our present equipment. Equipment now being obtained should give 100 times the signal - to - noise ratio and will permit a more detailed study

The second curve obtained was from the lens supplied to us by Col. Knäuf. The comparison between this curve and the previous curve is shown in Figure 9. There is only a slight difference between these two curves as observed at  $-196^{\circ}$  C. However, the decay curve for the second lens shows the presence of three distinct and measurable species of free radical. Many more measurements must be made before we can determine the exact differences and perhaps the species of free radical.

It is too soon to draw any more definite conclusions except that: (1) The free radicals to be used for observation do give a good signal-to-noise ratio, (2) the curve obtained from the unirradiated lens is quite simple and should show small changes quite readily, (3) there is only one predominant free radical species in the unirradiated rabbit lens and (4) there are only three, nearly equal, free radical species in the human lens supplied by Col. Knäuf. We do feel very enthused about these results and are looking forward to the results to be obtained soon.





EPR SPECTRUM OF A RABBIT  
WITH 2 MEGAREP AT  $-196^{\circ}\text{C}$

Best Available Copy

